



Presentation example PME76

Presentation example LME76

PME76.812Ax

Program module for burner control LME76.000Ax

User Documentation

- Application:**
- 1-stage or modulating, direct or pilot-ignited forced draft burners
 - Integrated actuator control via 3-position controller or analog signal
 - With or without actuator
 - Actuator has no CLOSED position, independent ignition load position above the low-fire
 - Flame failure response time can be parameterized.
For example, for burners to EN 676 or industrial thermo processing plants to EN 746 part 2
 - Continuous operation > 24 hours of uninterrupted operation

The PME76.812Ax and this user documentation are intended for original equipment manufacturers (OEMs) using the LME76.000Ax with PME76.812Ax in or on their products.



Note!

This documentation is only valid together with basic documentation LME75/LME76 (P7156)!

Overview

1	Supplementary documentation	4
2	Warning notes	5
3	Typographical conventions	6
4	PME76.812Ax program sequence	7
5	List of the phase display	9
6	Fuel trains (examples)	10
6.1	Gas direct ignition (G), 1-stage	10
6.2	Gas pilot ignition 1 (Gp1/1), 1-stage	11
7	Description of inputs on LME76	12
7.1	Air pressure switch terminal X3-02	12
7.1.1	Air pressure switch → specified time	12
7.1.2	Air pressure switch input	13
7.1.3	Response time to loss of air pressure	14
7.1.4	Omission of prepurging after standard shutdown according to EN 676:2003 + A2:2008 chapter 4.4.1.2 <i>Prepurging</i>	14
7.1.5	Extension of the prepurging process	15
7.1.6	Extension of the postpurging process	15
7.2	Gas pressure switch-min terminal X5-01	16
7.2.1	Response to loss of gas pressure switch-min input signal gas pressure	16
7.2.2	Evaluation of gas pressure switch-min input signal	17
7.3	POC terminal X2-02	18
7.4	Gas pressure switch-max terminal X9-04	19
7.5	Flame detector input	20
7.5.1	Ionization probe terminal X10-06	20
7.5.2	LFS1 terminal X10-05	21
7.6	Limitation of restarts	27
7.6.1	Restart in the event of loss of flame	27
7.6.2	Restart in the event of <i>no establishment of flame at the end of safety time</i> ..	27
7.7	Logical combination and evaluation	28
7.8	Parameterization of the extraneous light tolerance time in standby	28
7.9	Analog input load controller terminal X65	29
7.10	External load controller (ON/OFF) terminal X5-03	32
7.11	Safety loop terminal X3-04	34
8	Description of outputs on LME76	35
8.1	Fan motor terminal X2-01	35
8.2	Alarm / remote lockout reset terminal X2-03	35
8.2.1	Alarm terminal X2-03 pin 3	35
8.2.1	Remote lockout reset (reset) terminal X2-03 pin 1	35
8.3	Actuator terminal X2-09	36
8.3.1	Connection of feedback actuator position with ASZ in actuator at terminal X66	37

8.3.2	Engineering notes.....	37
8.3.3	Pin assignment of actuators for terminals X2-09 and X7-02 at LME76.....	38
8.3.3.1.	SQN70/SQN71.....	38
8.3.3.2.	SQN72.....	38
8.3.3.3.	SQM5.....	39
8.3.3.4.	SQM40/SQM41.....	39
8.4	Ignition transformer terminal X4-02.....	44
8.5	Safety valve terminal X6-03.....	44
8.6	Pilot valve PV terminal X7-01.....	44
8.7	Fuel valve V1 terminal X7-04.....	45
8.8	Actuator ignition load position terminal X7-02.....	45
9	Timetable and settings.....	46
10	Inputs and outputs / internal connection diagram.....	51
11	Parameter list (AZL2/ACS410).....	52
12	Error code list.....	60
13	Key.....	62
14	Table of Figures.....	63

1 Supplementary documentation

Product type	Designation	Documentation type	Documentation number
LME	Burner control	Environmental declaration	E7105 *)
LME	Burner control	Product range overview	Q7101
LME75/LME76	Burner control	Data sheet	N7156
LME75/LME76	Burner control	Basic documentation	P7156
PME	Program module	Environmental declaration	E7105.1 *)

*) On request only



Note!

This document only refers to the product type – not the *product designation*. See the table below for details.

Product type	Product designation
ACS410	PC software
ASZ	Potentiometer
AZL2	Display and operating unit
LFS1	Flame safeguard
QRA2	UV flame detector
QRA4	UV flame detector
QRA10	UV flame detector
RAR9	Photocell Detectors
SQN70	Actuator
SQN71	Actuator
SQN72	Actuator
SQN74	Actuator
SQN75	Actuator
SQM40	Actuator
SQM41	Actuator
SQM5	Actuator

2 Warning notes



Warning!

All the safety, warning, and technical notes given in the basic documentation LME75/LME76 (P7156) also apply to this document in full.

To avoid personal injury or damage to property or the environment, the following warning notes must be observed.

The LME76.000Ax is a safety device. Do not open, interfere with or modify the unit. Siemens does not assume responsibility for damage resulting from unauthorized interference!



Warning!

On the OEM access level of the LME76, it is possible to make parameter settings that differ from application standards. When setting the parameters, it is important to ensure that the application will run safely in accordance with legal requirements. Failure to observe this information poses a risk of damaging the safety functions.



Warning!

Risk of damage to the switching contacts!

If the external primary fuse (Si) is blown due to overload or short-circuit at the terminals, the LME76 must be replaced.

3 Typographical conventions

Safety notes

This user documentation contains notes that must be observed to ensure your personal safety and to prevent material damage. The instructions and notes are highlighted by warning triangles or a hand symbol and are presented as follows, depending on the hazard level:



Warning

means that death, severe personal injury or substantial damage to property **can** occur if adequate precautionary measures are not taken.



Caution

means that minor personal injury or property damage **can** occur if adequate precautionary measures are not taken.



Note

draws your attention to **important information** on the product, on product handling, or to a special part of the documentation.

Qualified personnel

Only **qualified personnel** are allowed to start up and operate the unit. Qualified personnel in the context of the safety-related notes contained in this user documentation are persons who are authorized to commission, ground, and tag units, systems, and electrical circuits in compliance with established safety practices and standards.

Correct use

Note the following:

The unit may only be used for the applications described in the technical documentation and only in conjunction with devices or components from other suppliers that have been approved or recommended by Siemens.

The product can only function correctly and safely if shipped, stored, set up, and installed correctly, and operated and maintained with care.

4 PME76.812Ax program sequence

→ For fuel trains G and Gp1/1

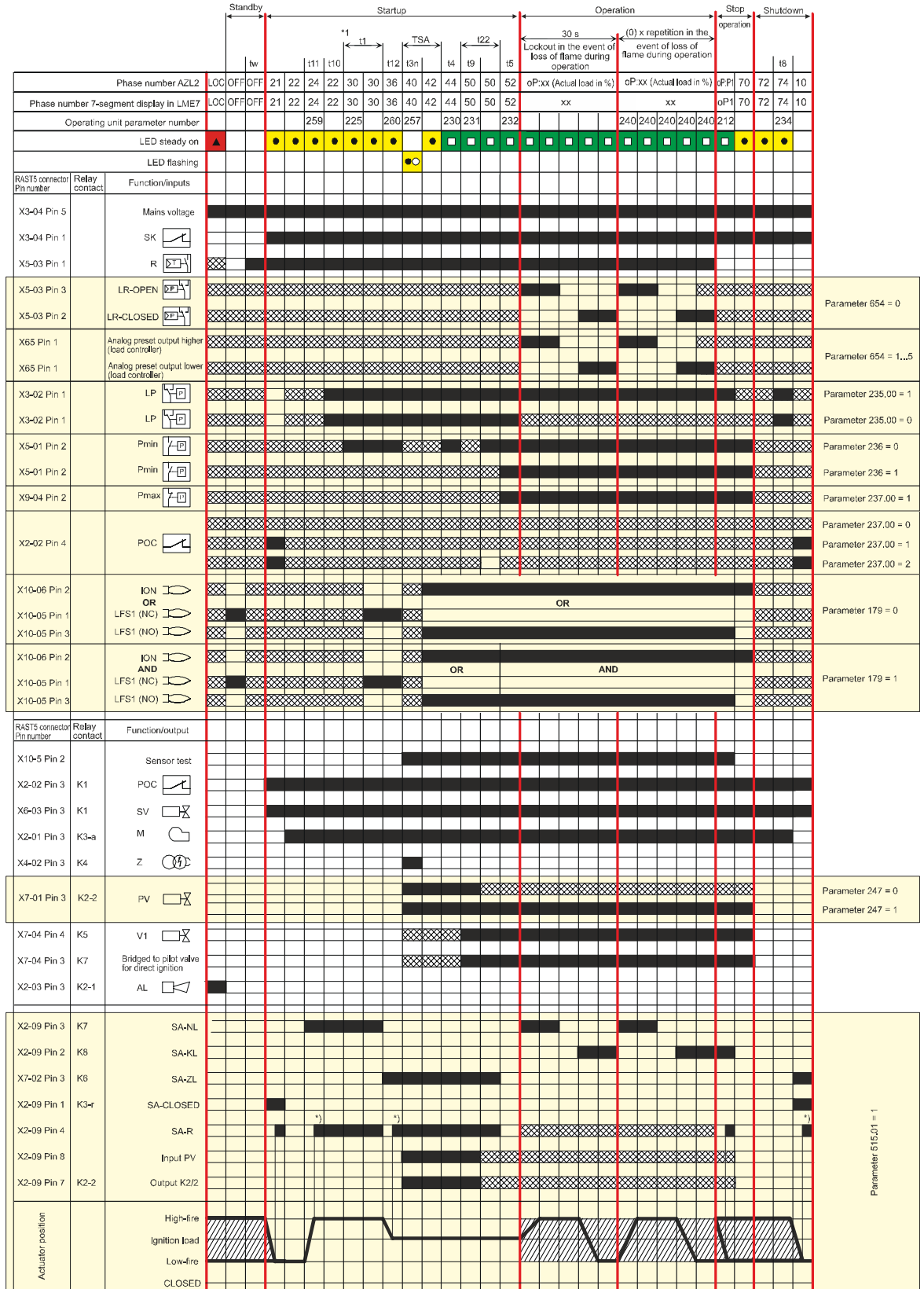

Figure 1: Program sequence for fuel trains G and Gp1/1

Caution!
Factory setting:
Parameter 217.01 → Flame failure response time in case of loss of flame
3 seconds! For a response time of 1 second, the parameter 217.01 must be
changed to 0.



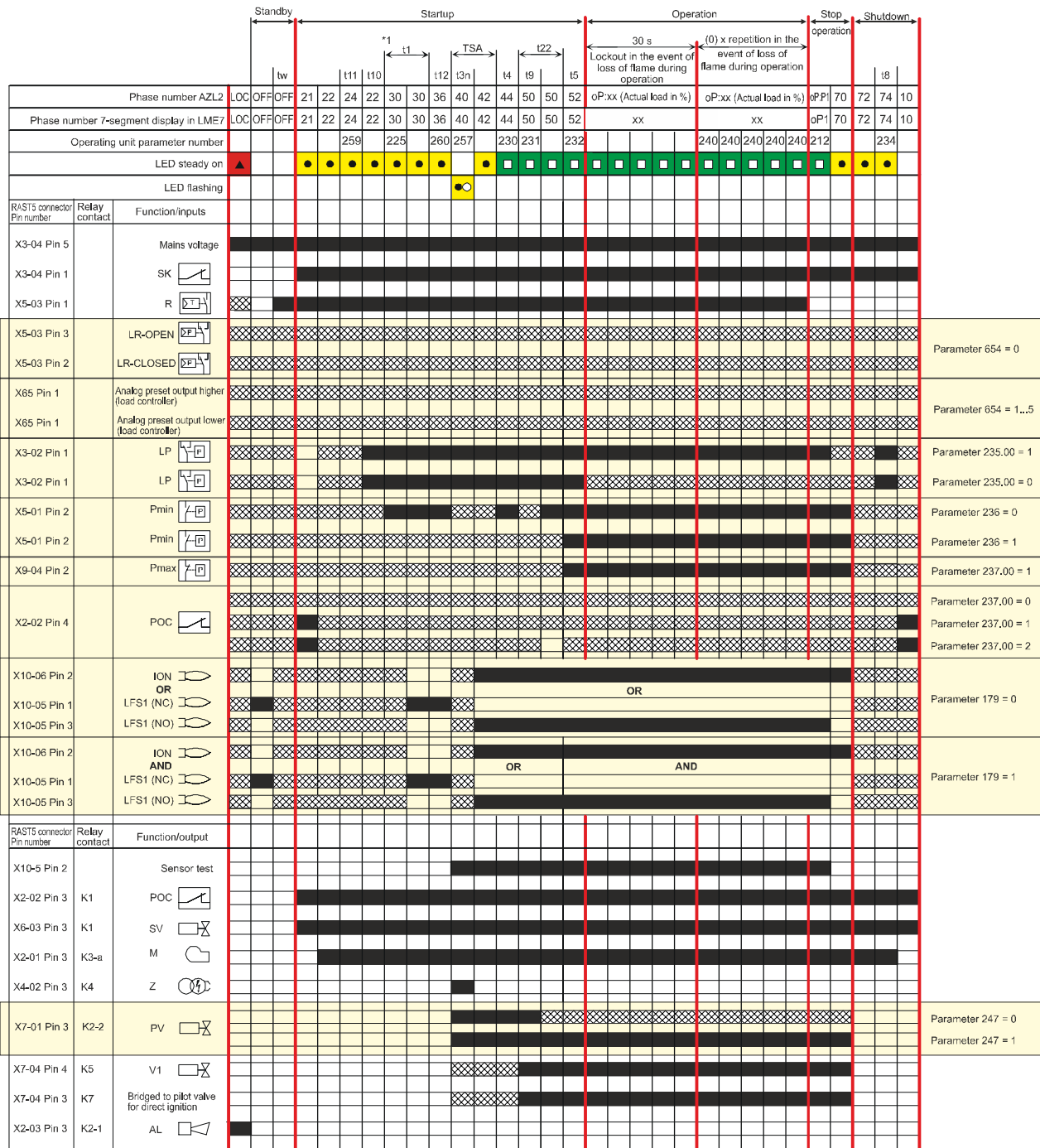

Figure 2: Program sequence for fuel trains G and Gp1/1

7156d58en/0919



Note!
 Operation without actuator control (parameter 515.01 = 0)!
 A Dbr3 wire link is required at terminal X2-09B from pin 7 to pin 8 required.



Warning!
Voltage at actuator plug-in space X2-09!
 A suitable cover provided by the OEM must provide protection against electric shock hazard at plug-in space X2-09. In terms of design, stability, and protection, covers must conform to EN 60730. Failure to observe this poses a risk of electric shock.

- *) During the actuator running phases, the actuator feedback signal must first be OFF, then ON
- *1 No prepurging (t1), if parameter 222 = 0 and there has been a successful shutdown

5 List of the phase display

Phase number display		LED	Function
7-segment	AZL2		
LOC	LOC	Red	Lockout phase
Standby			
OFF	OFF	OFF	Standby, waiting for heat request
P08	Ph08	OFF	Power ON / test phase (e.g., detector test)
Startup			
P21	Ph21	Yellow	Safety valve ON, air pressure switch in no-load position Actuator travels to CLOSED position
P22	Ph22	Yellow	Part 1: Fan motor ON Part 2: Specified time air pressure switch Message (timeout), stabilization air pressure switch
P24	Ph24	Yellow	Actuator travels to the prepurge position (timeout)
P30	Ph30	Yellow	Part 1: Prepurge time without extraneous light test Part 2: Prepurging with extraneous light test (1 second)
P36	Ph36	Yellow	Actuator closed in ignition load / low-fire
P40	Ph40	Flashing yellow	First safety time / ignition transformer ON
P42	Ph42	Green	Safety time (ignition transformer OFF), flame check
P44	Ph44	Green	Interval: End of safety time and fuel valve V2 ON
P50	Ph50	Green	Second safety time, fuel valve V2 ON
P52	Ph52	Green	Interval until release of load controller target (analog or 3-position step input)
P54	Ph54	Green	Parameter 260: Actuator closed in low-fire
Operation			
xx	oP:xx	Green	Operation (modulation), actual load displayed in percent
Shutdown			
P10	Ph10	OFF	Actuator travels to CLOSED position (home run)
P70	Ph70	Yellow	Stop operation
P72	Ph72	Yellow	Stop operation
P74	Ph74	Yellow	Postpurge time
Safety shutdown phases			
P01	Ph01	Yellow/red	Undervoltage/overvoltage
P02	Ph02	Yellow	Safety shutdown, followed by a non-alterable lockout with interlocking → e.g., safety loop open
P04	Ph04	Green/red	Extraneous light during burner startup / standby (timeout / locking after 30 seconds)
P90	Ph90	Yellow	Gas pressure switch-min open Parameter 223 = 0 → Safety shutdown and start prevention Parameter 223 = 1 → Non-alterable lockout

6 Fuel trains (examples)

6.1 Gas direct ignition (G), 1-stage

LME76.000...

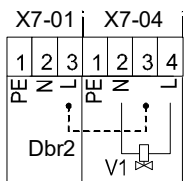

LME76.000...

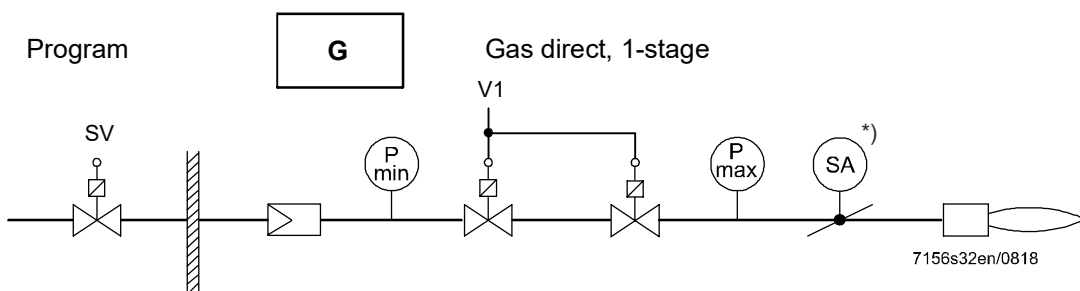
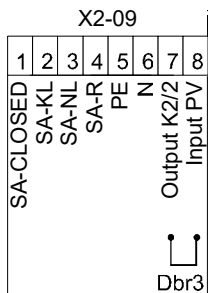

Fuel valve control

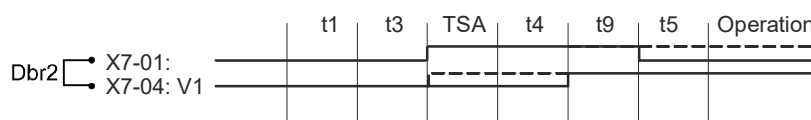

Figure 3: Fuel train gas direct ignition (G), 1-stage

*) Optional

Legend

- Without Dbr2
- - - - With Dbr2



Note!

In the case of gas direct ignition (G), fuel valve V1 is switched on via terminal X7-01.

Observe the maximum permissible contact rating for terminal X7-01:

Rated voltage	120 V AC	230 V AC
	50/60 Hz	50/60 Hz
Rated current	1 A	1 A
Power factor	$\cos\varphi > 0.4$	$\cos\varphi > 0.4$

6.2 Gas pilot ignition 1 (Gp1/1), 1-stage

LME76.000...

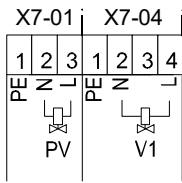

LME76.000...

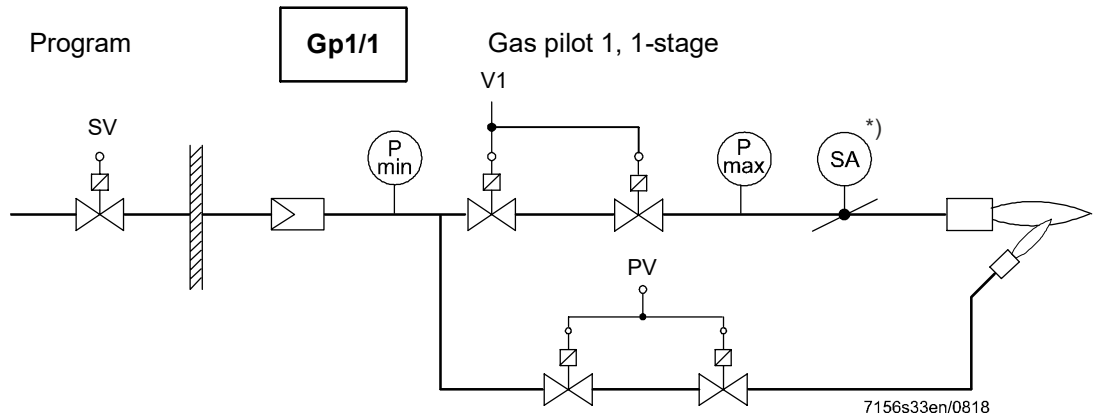
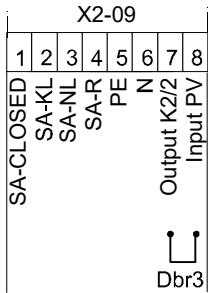

Fuel valve control

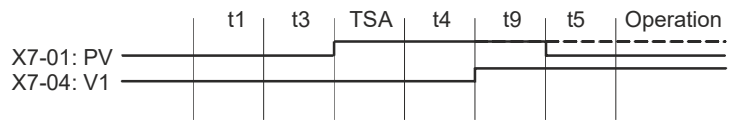

Figure 4: Fuel train gas pilot ignition 1 (Gp1/1), 1-stage

*) Optional

Legend

- Parameter 247 = 1
- - - - - Parameter 247 = 0

7 Description of inputs on LME76



Note!

This chapter covers the basic features of the LME76 inputs.
For an exact evaluation and activation of the inputs, see the program sequences in chapter 4 *PME76.812Ax program sequence*.

7.1 Air pressure switch terminal X3-02

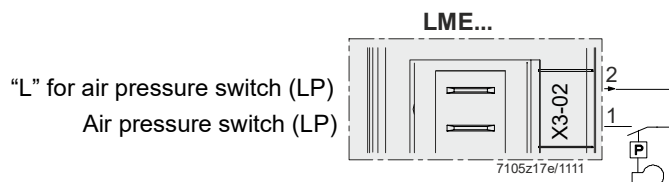

Figure 5: Air pressure switch terminal X3-02

7.1.1 Air pressure switch → specified time

Parameter	Function
224	Air pressure switch → specified time

Input for connection of an air pressure switch. Within the specified time (t_{10}) (parameter 224), the air pressure switch must close after switching on the fan and – if necessary – after reaching the high-fire position of the actuator (parameter 515.01 = 1). Otherwise a non-alterable lockout takes place (lockout code Loc: 3). The air pressure switch must have an NO contact. The air pressure switch test (specified time) takes place within phase 22.

7.1.2 Air pressure switch input

Parameter	Function
235.00	Air pressure switch input 0 = no evaluation of the air pressure switch during operation (evaluation only during prepurging and, if necessary, postpurging) 1 = evaluation of the air pressure switch during prepurging and postpurging, as well as when in the operating position

Parameter access: OEM level

Evaluation of the air pressure switch input signal can be changed via the selection in parameter 235.00.

Where parameter 235.00 = 0

No evaluation of the air pressure switch during burner operation (from phase 44 to the end of phase *oP:xx*). Evaluation only during prepurging and, if necessary, postpurging (according to EN 676:2003 + A2:2008, chapter 4.3.4.11 *Air monitoring device*).

Parameter 235.00 = 1

Evaluation of the air pressure switch from phase 22 (fan motor ON).

If no air pressure switch is required, e.g., for atmospheric applications, a wire link to the fan output must be fitted (terminal X3-02 pin 1 to terminal X2-01 pin 3).



Warning!

The OEM must check to see whether the burner can be operated without an air pressure switch. This may necessitate a special approval depending on the application.

7.1.3 Response time to loss of air pressure

Parameter	Function
235.01	Air pressure switch – response time to loss 0 = typically 0.7 seconds ≥ 0 = additional delay in response to faulty air pressure switch

Parameter access: OEM level

Parameter 235.01 ≥ 0

Additional delay on loss of air pressure is typically 0.7 seconds + set delay.

Parameter 235.01 = 0.294 (factory setting)

The response time to a faulty air pressure switch is ≤1 second.

Example

Typically 0.7 s + 2.058 s = 2.758 s (corresponds to < 3 s according to EN 746-2, chapter 5.2.5.3.4.2 *Maximum safety times for burners without fan*, table 2)

7.1.4 Omission of prepurging after standard shutdown

according to EN 676:2003 + A2:2008 chapter 4.4.1.2

Prepurging

Parameter	Function
222	Prepurging 0 = inactive 1 = active

Parameter access: OEM level

Parameter 222 = 0

Omission of prepurging after standard shutdown (according to EN 676, chapter 4.4.1.2 *Prepurging*)

Restrictions:

Prepurging must be performed:

- Following unlocking from a non-alterable lockout
- After 24 hours of standby
- After power OFF/ON
- Start prevention, safety shutdown due to gas shortage

Parameter 222 = 1

Prepurging on every burner startup.

7.1.5 Extension of the prepurging process

Parameter	Function
225.00	Prepurge time (t1)
225.01	Multiplicator of prepurge time (t1) (extension of prepurge time)

If required, the prepurge time can be extended to > 20 minutes and up to 87 hours. The two parameters 225.00 (prepurge time) and parameter 225.01 (multiplicator for prepurge time) can be used to this end.

The prepurge time corresponds to the time set in parameter 225.00 multiplied by parameter 225.01.

Example for a prepurge time of 1 hour:

Parameter 225.00 = 1203.048 s x parameter 225.01 = 3

→ 3609.144 s ~ 60.15 min ~ 1 h

Setting the prepurging to 1 hour can also be achieved with other combinations of the two parameters.

The factory setting is:

Parameter 225.00 = 29.106 s x parameter 225.01 = 1 → 29.106 s

7.1.6 Extension of the postpurging process

Parameter	Function
234.00	Postpurge time (t8) (no extraneous light test)
234.01	Multiplicator of postpurge time (t8) ((extension of postpurging)

If required, the postpurge time can be extended to > 20 minutes and up to 87 hours. The two parameters 234.00 (postpurge time) and parameter 234.01 (multiplicator for postpurge time) can be used to this end.

The postpurge time corresponds to the time set in parameter 234.00 multiplied by parameter 234.01.

Example for a postpurge time of 1 hour:

Parameter 234.00 = 1203.048 s x parameter 234.01 = 3

→ 3609.144 s ~ 60.15 min ~ 1 h

Setting the postpurge to 1 hour can also be achieved with other combinations of the two parameters.

The factory setting is:

Parameter 234.00 = 0 s x parameter 234.01 = 1 → 0 seconds (no postpurge)

7.2 Gas pressure switch-min terminal X5-01

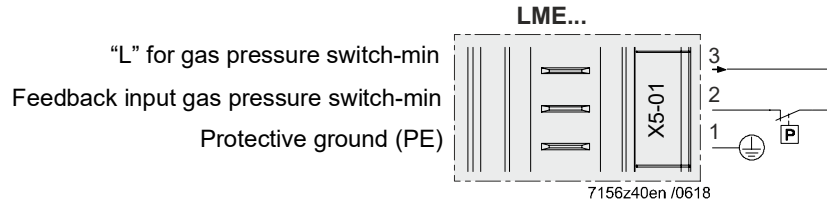

Figure 6: Gas pressure switch-min terminal X5-01

Parameter	Function
223	Gas pressure switch-min – response to loss 0 = safety shutdown and start prevention 1 = non-alterable lockout
236	Input pressure switch-min 0 = permanent evaluation 1 = in operation only (after second safety time)

Parameter access: OEM level

7.2.1 Response to loss of gas pressure switch-min input signal gas pressure

Parameter access: OEM level

The response to loss of *gas pressure switch-min input signal* gas pressure can be changed via the selection in parameter 223.

Parameter 223 = 0

If the gas pressure switch-min fails, a safety shutdown and start prevention are performed.

Evaluation of the air pressure switch from phase 30 (prepurging).

During start prevention, the yellow signal lamp lights up and the safety loop is active.

The LME76 is in phase 90.

Once the gas pressure has been restored, a restart is carried out.

Parameter 223 = 1

If the *gas pressure switch-min* gas pressure fails, a non-alterable lockout is performed (Loc: 20).

7.2.2 Evaluation of gas pressure switch-min input signal

Parameter access: OEM level

Evaluation of the *gas pressure switch-min input signal* gas pressure can be changed via the selection in parameter 236.

Parameter 236 = 0

Evaluation of the gas pressure switch from phase 30 (prepurging).

Permanent evaluation (except for in the first and second safety times).

Parameter 236 = 1

In operation only (after second safety time, e.g., according to Canadian standard CSA B149.3-10, chapter 9.5.3 *Pilot Gas Supply*, or EN 676:2003 + A2:2008, Annex B).

7.3 POC terminal X2-02

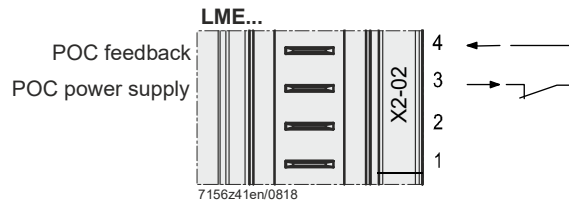

Figure 7: POC terminal X2-02

Parameter	Function
237.00	<p>Input for POC</p> <p>0 = inactive → Input does not need to be connected</p> <p>1 = active (test during startup and shutdown (not safety relevant)) → POC is checked for closed during startup and shutdown. This means that the POC can be replaced with a wire link Dbr1.</p> <p>2 = active (test during startup and shutdown, as well as when switching to operating mode (safety relevant)) → POC is checked for closed during startup and shutdown and checked for open when switching to operating mode. This means that a signal change must take place by switching the POC.</p>

Parameter 237.00 defines if and how the POC is tested.

An incorrect signal from the POC (parameter 237.00 > 0) is detected in the relevant phases. A non-volatile lockout takes place (lockout code Loc: 14). Factory setting of parameter 237.00 = 1. This means the POC is active and can be replaced with a wire link Dbr1.

Parameter access: Heating engineer (HF) level



Warning!

Welding the contact.

If several contacts are connected in series, the valve closure contact (POC) must not be welded in the closed position.

7.4 Gas pressure switch-max terminal X9-04

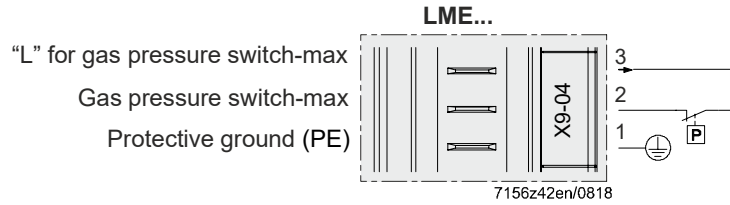

Figure 8: Gas pressure switch-max terminal X9-04

Parameter	Function
237.01	Function input for gas pressure switch-max terminal X9-04 0 = inactive 1 = active

A gas pressure switch-max can be connected at function input terminal X9-04 pin 2 / pin 3.

Setting the parameter:

Parameter 237.01 = 1 (input for gas pressure switch-max)

The gas pressure switch-max function can be activated by parameter 237.01 = 1. When the gas pressure switch-max function is active, the gas pressure switch-max monitors the maximum gas pressure and opens if it is exceeded. Monitoring takes place during operation, from the second interval on (t5). If the maximum gas pressure is exceeded and the gas pressure switch-max opens, a non-alterable lockout is performed with lockout code 21. Before the second interval, there is no response if the gas pressure switch-max opens.

7.5 Flame detector input

7.5.1 Ionization probe terminal X10-06

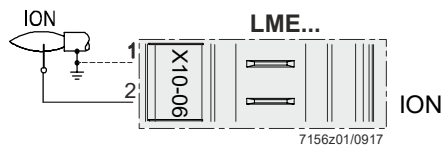

Figure 9: Ionization probe terminal X10-06

Parameter	Function
179	Logical combination of both flame signal amplifier channels 0 = flame signal amplifier channels are logically combined with an OR operation (ionization OR LFS1) 1 = flame signal amplifier channels are logically combined with an AND operation (ionization AND LFS1)
217.00	Flame signal flame-on response time (extension) (not adjustable) 0 = maximum 1 second with ionization probe, maximum 2 seconds with LFS1
217.01	Flame signal flame-out response time (extension) 0 = maximum 1 second with ionization probe, maximum 2 seconds with LFS1 ≥ 0 = additional extension to response to a flame fault
240	Restart in the event of loss of flame during operation and in the event of no flame at the end of the safety time 0 = no restart 1 = no restart 2 = 1x restart 3 = 2x restart 4 = 3x restart
954.00	Intensity of flame for ionization probe (0...100%)

Response time

Parameter access: OEM level

Parameter 217.01 = 0

The response time to a flame fault (flame fault response time) is ≤ 1 second.

Parameter 217.01 ≥ 0

Additional delay on flame fault (flame fault response time) is 1 second + set delay.

Example

$1 \text{ s} + 1.911 \text{ s} = 2.911 \text{ s} \sim 3 \text{ s}$ (e.g., EN 746-2, chapter 5.2.5.3.4.2 *Maximum safety times for burners without fan*, table 2)



Caution!

Factory setting:

Parameter 217.01= 1.911 seconds

→ Flame failure response time in case of loss of flame ≤ 3 seconds!

For a response time of 1 second with an ionization probe, the parameter 217.01 must be changed to 0.



Caution!

Ensure the correct polarity of the ionization probe connecting wires.

If connected incorrectly to terminal X10-05, there is a risk that the LME76 and ionization probe may malfunction.

7.5.2 LFS1 terminal X10-05

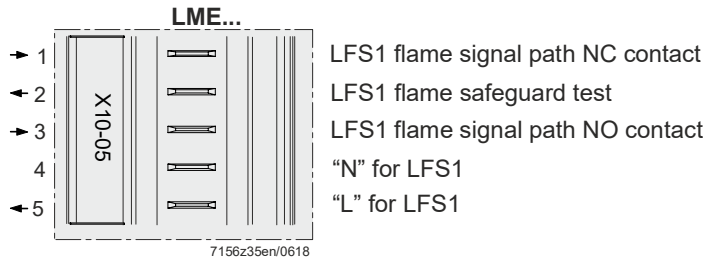

Figure 10: LFS1 terminal X10-05

Parameter	Function
179	Logical combination of both flame signal amplifier channels 0 = flame signal amplifier channels are logically combined with an OR operation (ionization OR LFS1) 1 = flame signal amplifier channels are logically combined with an AND operation (ionization AND LFS1)
217.00	Flame signal flame-on response time (extension) (not adjustable) 0 = maximum 1 second with ionization probe, maximum 2 seconds with LFS1
217.01	Flame signal flame-out response time (extension) 0 = maximum 1 second with ionization probe, maximum 2 seconds with LFS1 ≥ 0 = additional extension to response to a flame fault
240	Restart in the event of loss of flame during operation and in the event of no flame at the end of the safety time 0 = no restart 1 = no restart 2 = 1x restart 3 = 2x restart 4 = 3x restart
954.01	Intensity of flame LFS1 (0% or 100%)



Warning!

In the event of flame supervision with LFS1, the *flame signal flame-out-response time* (flame fault response time) must be observed.

Response time

Parameter access: OEM level

Parameter 217.01 = 0

The response time to a flame fault (flame signal flame-out response time) is ≤ 2 seconds.

Parameter 217.01 ≥ 0

Total delay time to flame fault (flame signal flame-out response time, extension) is 2 seconds + set delay.

Example

$2\text{ s} + 1.911\text{ s} = 3.911\text{ s} \sim 4\text{ s}$



Caution!

Factory setting:

Parameter 217.01= 1.911 seconds

→ Flame failure response time in case of loss of flame ≤ 4 seconds!

For a response time of 2 seconds with LFS1, the parameter 217.01 must be changed to 0 seconds.



Note!

Maximum response time in the event of loss of flame!

Parameter 217.01 = 0 seconds (no factory setting)

The maximum response time in the event of a flame fault at the LFS1 input can be up to 2 seconds (typically 1.2 seconds). For applications subject to the standard response time in the event of loss of flame of ≤ 1 second, this results in the limit value being exceeded. The LME76 with LFS1 cannot be used in these applications.



Caution!

Continuous operation of the LME76 with LFS1 is only permitted in connection with...

- LFS1.11Ax and RAR9
- LFS1.21Ax and ionization probe

It is only permitted to operate the LME76 with the LFS1.21Ax and QRA2/QRA4/QRA10 intermittently (with a maximum continuous operation of 24 hours).

Parameter 239 = 1 and parameter 218 = 80050.31 s or with external control via heat request < 24 hours.

		Intensity of flame
Required flame signal during operation	Mains voltage at terminal X10-05 pin 3 and no mains voltage at terminal X10-05 pin 1	100%
No flame signal during operation	Mains voltage at terminal X10-05 pin 1 or no mains voltage at terminal X10-05 pin 3	0%
Extraneous light in standby/startup	Mains voltage at terminal X10-05 pin 3 or no mains voltage at terminal X10-05 pin 1	100%
No extraneous light in standby/startup	Mains voltage at terminal X10-05 pin 1 and no mains voltage at terminal X10-05 pin 3	0%

Parameter	Function
954.01	Intensity of flame LFS1 (0% or 100%)

For more detailed information on LFS1, refer to data sheet N7782 and user documentation A7782.

Flame safeguard test

During the prepurging process, the LFS1 is in test mode (flame safeguard test output X10-05 pin 2 inactive). During operation (from the first safety time), the LFS1 is in operating mode (flame safeguard test output X10-05 pin 2 active). A flame safeguard test takes place at the start of the shutdown. A non-alterable lockout (Loc: 31) takes place in the event of a fault with the flame safeguard.



Warning!

Risk of mixing up with LME71/LME73.

Only LFS1 may be connected to connection terminal X10-05.

Only an ionization probe may be connected to connection terminal X10-06.

Failure to observe this information poses a risk of loss of device functions or a fault in the LME76 unit.



Caution!

Ensure the LFS1 connection wires are connected properly and in-phase. If connected incorrectly to terminal X10-05, there is a risk that the LME76 and LFS1 may malfunction.



Note!

If an ionization probe is operated an LFS1 simultaneously, be sure to note the parameter settings!

7.5.2.1 Connection diagram of an ionization probe only without LFS1

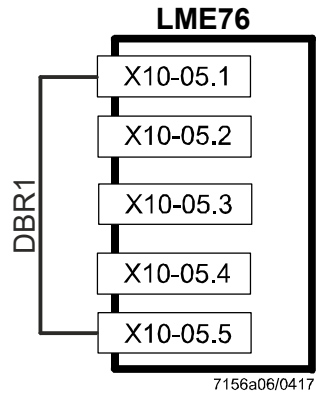

Figure 11: Connection diagram of an ionization probe only without LFS1

7.5.2.2 Connection diagram with LFS1

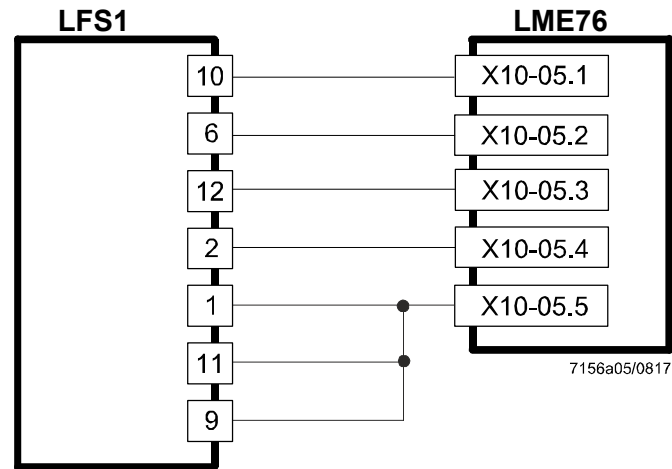

Figure 12: Connection diagram with LFS1



Caution!

Refer to the documentation for the LFS1

→ Data sheet N7782

→ User documentation A7782

7.5.2.3 Connection diagram with 2x LFS1 in logical OR operation

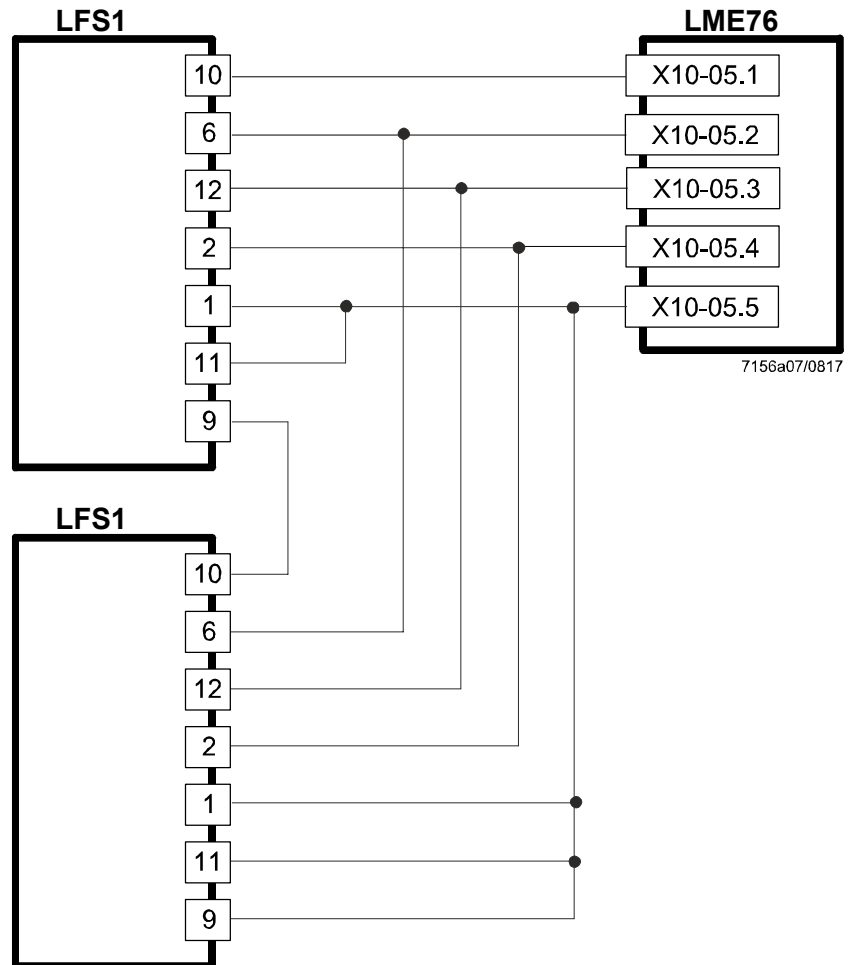

Figure 13: Connection diagram with 2x LFS1 in logical **OR** operation

Note!

Flame signal at LFS1 input with 2x LFS1 in logical **OR** operation. There must be a flame signal present at least one of the two LFS1 units in burner operation. As soon as there is no flame signal left at both LFS1 units, the flame signal at the LFS1 input also extinguishes.

7.5.2.4. Connection diagram with 2x LFS1 units in logical AND operation

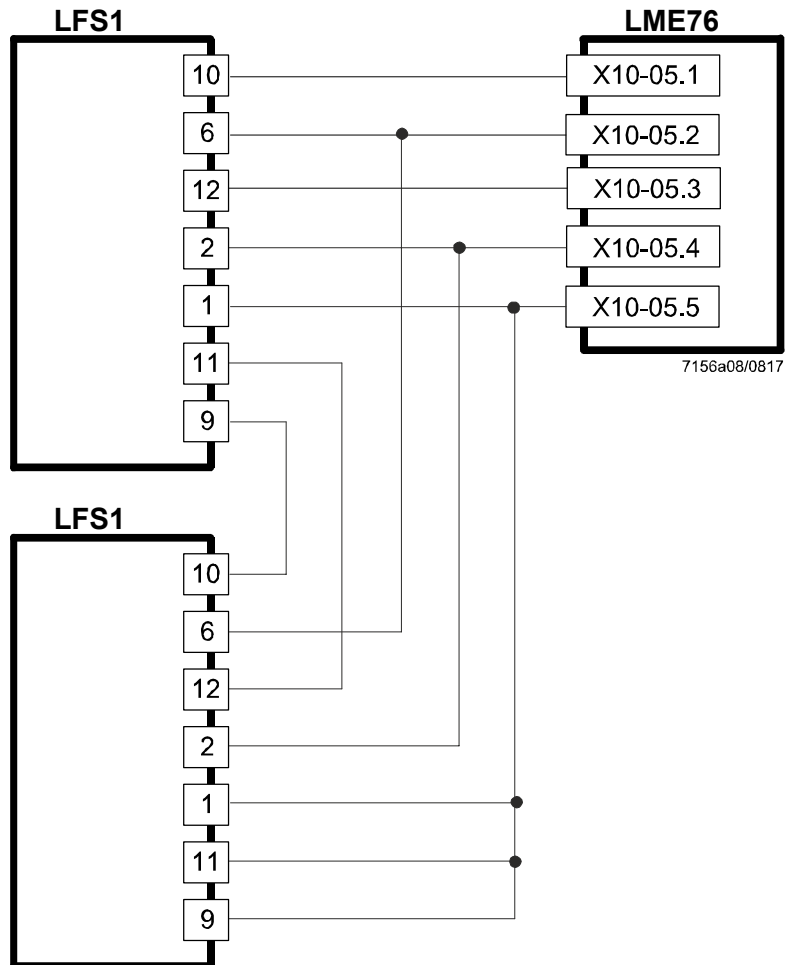

Figure 14: Connection diagram with 2x LFS1 in logical **AND** operation

Note!

Flame signal at LFS1 input with 2x LFS1 in logical **AND** operation. There must be a flame signal present at both LFS1 units in burner operation. As soon as there is no flame signal left at one of the two LFS1 units, the flame signal at the LFS1 input also extinguishes.

7.6 Limitation of restarts

Parameter	Functions
240	Restart in the event of loss of flame during operation and in the event of no flame at the end of the safety time 0 = no restart 1 = no restart 2 = 1x restart 3 = 2x restart 4 = 3x restart

7.6.1 Restart in the event of loss of flame

If the flame is lost during operation, several restarts per controlled startup can be performed via the control thermostat or pressurestat, or else a non-alterable lockout will be initiated. With restarts from the operating position (loss of flame), the flame must have been established on completion of the safety time, or else a non-alterable lockout will be initiated.

7.6.2 Restart in the event of *no establishment of flame at the end of safety time*

If there is *no establishment of flame at the end of safety time*, several restarts per controlled shutdown are possible.

7.7 Logical combination and evaluation

Parameter access: OEM level

The two flame signal inputs (ionization and LFS1) can be combined for the operating position *logical AND* or *logical OR* via the selection in parameter 179.

Parameter 179 = 0

Combination of flame signal inputs *logical OR*.

OR operation

A flame signal must be present at one of the two flame signal inputs in burner operation (after end of phase 42 to end of phase oP:xx).

As soon as a flame signal is no longer present during operation, a non-alterable lockout is performed (Loc: 2).

Parameter 179 = 1

Combination of flame signal inputs *logical AND*.

At the end of the first safety time (end of phase 42) until the end of phase 50, at least one of the two flame signals must be available. If no flame signal has been established at the end of the first safety time (end of phase 42), a non-alterable lockout is performed (Loc: 2).

At the end of the second safety time (end of phase 50) until the end of burner operation (end of phase oP:xx), both flame signals must be available. If at least one of the two flame signals extinguishes from the end of the second safety time (end of phase 50) until the end of burner operation (end of phase oP:xx), a non-alterable lockout is performed (Loc: 7).



Note!

An **OR** operation is always used for extraneous light detection in the startup and shutdown phases.

This means that, as soon as a flame signal is detected at one of the two flame signal inputs during extraneous light detection (phase 30), a non-alterable lockout is performed (Loc: 4).

7.8 Parameterization of the extraneous light tolerance time in standby

Parameter	Function
216	Extraneous light tolerance time in standby

In the event of an extraneous light signal in standby, a signal is output via the LED (red/green) and via the 7-segment display (P04) / AZL2 (Ph04). Once the extraneous light tolerance time in standby has elapsed, a non-alterable lockout is performed (Loc: 4). This extraneous light tolerance time can be configured by parameter 216 in the range of 0...1,237 seconds (factory setting 30 seconds).

7.9 Analog input load controller terminal X65

PME76.812Ax

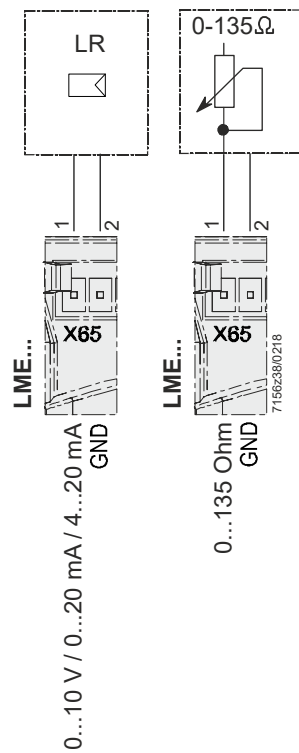



Figure 15: Load controller terminal X65

Parameter	Function
140	Mode display in the 7-segment display 1 = standard (program phase) 2 = flame 1 (ionization) 3 = flame 2 (LFS1) 4 = active power (power value)
515.00	Actuator position during prepurge time (not adjustable) 1 = purging in high-fire
515.01	Actuator control 0 = OFF 1 = ON
	 <p>Note! Setting = 0 No actuators may be connected and parameter 560 must be set to 0. The wire link Dbr3 is also required between terminal X2-09B pin 7 and terminal X2-09B pin 8.</p>
560	Pneumatic combustion control 0 = OFF / 3-position step modulation 1 = PWM fan motor / analog modulation
	 <p>Note! Setting = 1 No function. This selection puts the LME76 in lockout position.</p>
	2 = Air damper / analog modulation (ASZxx.3x feedback required)
654	Only with analog modulating (parameter 560 = 2) Analog input (ASZxx.3x feedback required) 0 = 3-position step input 1 = 0...10 V 2 = 0...135 Ω 3 = 0...20 mA 4 = 4...20 mA with a non-alterable lockout at I < 4 mA 5 = 4...20 mA without a non-alterable lockout at I < 4 mA

The following input signals can be selected and handled via parameter 654:

- 3-position step input (feedback ASZxx.3x required / depending on the program sequence)
- 0...10 V
- 0...135 Ω
- 0...20 mA
- 4...20 mA with a non-alterable lockout at I < 4 mA (AZL2: Loc: 60)
- 4...20 mA without a non-alterable lockout at I < 4 mA



Note!
Shielded cables must be used if cables are > 10 m.

Parameter access: Heating engineer level

The function of the analog input *load controller* terminal X65 can be adapted via parameter 654.

Parameter 654 = 0
3-position step input

With this setting, load control takes place solely via the contact inputs for the external load controller terminal X5-03 pin 2 and 3.

Parameter 654 = 1...4
Load control via analog input terminal X65

With this setting, load control takes place via a preset analog value.
An analog signal (terminal X65) is only taken into account in the operating phases (oP).
If a signal is present during startup, shutdown, standby, and in the lockout position, it is ignored.



Note!

Load control via analog input terminal X65 always requires an actuator with a built-in potentiometer for position feedback.

The display mode for the internal 7-segment display is defined via parameter 140.

Setting 1 = standard (program phase, factory setting)

Setting 2 = flame 1 (ION)

Setting 3 = flame 2 (LFS1)

Setting 4 = active power

(power value, only for actuators with a built-in ASZ for position feedback)

7.10 External load controller (ON/OFF) terminal X5-03

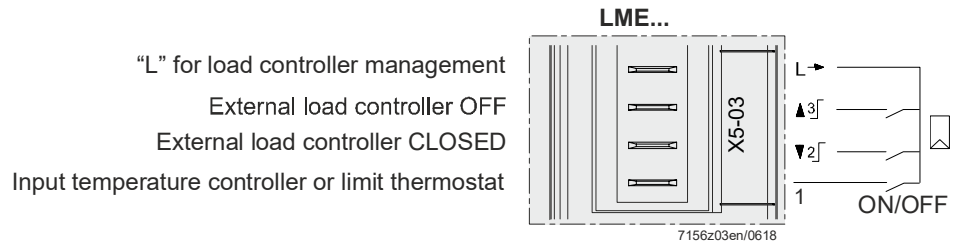

Figure 16: Load controller ON/OFF terminal X5-03

Parameter	Function
212	Running time of the actuator to the low-fire position on shutdown 0 seconds: Shutdown in the final actuator position > 0 seconds: Actuator travels to low-fire position → shutdown takes place
225.00	Prepurge time (t1)
225.01	Multiplicator of the prepurge time (t1) (extension of prepurge time)
232	Interval (t5): Stabilization time main flame
234.00	Postpurge time (t8) (no extraneous light test)
234.01	Multiplicator of postpurge time (t8) (extension of postpurging)
239	Controlled intermittent operation after 24 hours of continuous operation 0 = OFF 1 = ON
515.00	Actuator position during prepurge time (not adjustable) 1 = purging in high-fire
515.01	Actuator control 0 = OFF 1 = ON
	<p>Note! Setting = 0 No actuators may be connected and parameter 560 must be set to 0. The wire link Dbr3 is also required between terminal X2-09B pin 7 and terminal X2-09B pin 8.</p>
560	Pneumatic combustion control 0 = OFF / 3-position step modulation 1 = PWM fan motor / analog modulation
	<p>Note! Setting = 1 No function. This selection puts the LME76 in lockout position.</p>
	2 = Air damper / analog modulation (ASZxx.3x feedback required)
654	Only with analog modulating (parameter 560 = 2) Analog input (ASZxx.3x feedback required) 0 = 3-position step input 1 = 0...10 V 2 = 0...135 Ω 3 = 0...20 mA 4 = 4...20 mA with a non-alterable lockout at I < 4 mA 5 = 4...20 mA without a non-alterable lockout at I < 4 mA

The load controller input is evaluated by making a 2-out-of-3 selection. This means that to trigger a control action via the actuator outputs, an ON or OFF signal must be identified within at least 2 successive cycles. As a result of this sampling process, an ON or OFF signal must be present for a time between minimum 0.3 seconds and maximum 0.45 seconds to produce an output signal change at the LME76.000Ax.

Terminal X5-03 pin 1

Heat request (input external temperature controller or limit thermostat):

The burner starts if a signal (L → terminal X5-03 pin 4) is present at pin 1.

The burner shuts down and then enters standby once a heat request is no longer present.

Shutdown sequence (parameter 212)

When deactivating the heat request at terminal X5-03 pin 1, the actuator is closed toward the low-fire position for the parameterized running time (parameter 212). If the running time (parameter 212) elapses or the actuator reaches the low-fire position, the actuator stops closing and the burner operation ends. The shutdown takes place once the actuator has reached its position.

Postpurging takes place depending on the parameter settings. If parameter 212 = 0, the shutdown takes place in the final operating position of the actuator prior to deactivating the heat request.

Terminal X5-03 pin 2

Load controller CLOSED (input *external load controller CLOSED*)

A signal (L → terminal X5-03 pin 4) at pin 2 is only taken into account in the operating phases (oP). If a signal is present during startup, shutdown, standby, and in the lockout position, it is ignored. The actuator travels toward the low-fire position, depending on the input signal. If no signal is present, the actuator stays in the position it has reached.

Terminal X5-03 pin 3

Load controller OPEN or stage 3 (input *external load controller OPEN*)

A signal (L → terminal X5-03 pin 4) at pin 3 is only taken into account in the operating phases (oP). If a signal is present during startup, shutdown, standby, and in the lockout position, it is ignored. The actuator travels toward the high-fire position, depending on the input signal. If no signal is present, the actuator stays in the position it has reached.

7.11 Safety loop terminal X3-04

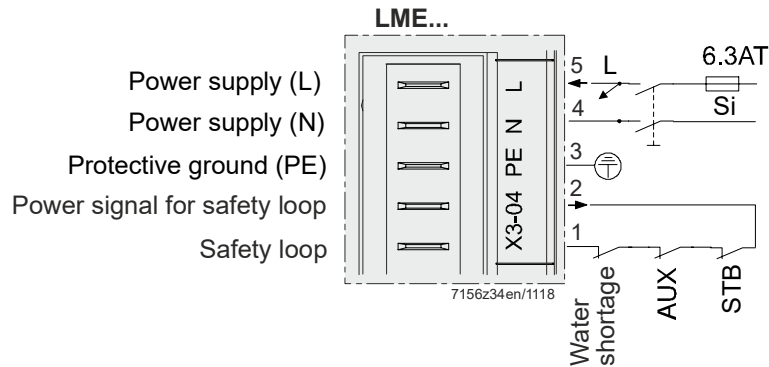

Figure 17: Safety loop terminal X3-04

Input for the safety loop. When any of the series-connected contacts included in the loop opens, power supply to the fuel valves, the fan, and the ignition is instantly cut.

The following contacts are included in the safety loop:

- Safety limiter / safety pressure limiter
- External limit thermostat and/or pressure switch, if required
- Water shortage switch

For diagnostic purposes, the contacts of the components included in the safety loop are combined for delivering the *safety loop* signal.

If the safety loop is not closed during a heat request (load controller ON/OFF at terminal X5-01 pin 3), a non-alterable lockout is performed, error code **Loc: 22**.



Note!

The power signal for the safety loop is only active if a heat request (load controller ON/OFF) is present at terminal X5-01 pin 3. In the lockout position, the power signal switches off too.



Warning!

The in-phase connection of the power supply must be observed. Failure to observe this information poses a risk of loss of device functions.

8 Description of outputs on LME76



Note!

This chapter covers the basic features of the LME76 outputs. For an exact evaluation and activation of the outputs, see the program sequences in chapter 4 *PME76.812Ax program sequence*.

8.1 Fan motor terminal X2-01



Figure 18: Fan motor terminal X2-01

Output for connection of a fan motor.

8.2 Alarm / remote lockout reset terminal X2-03

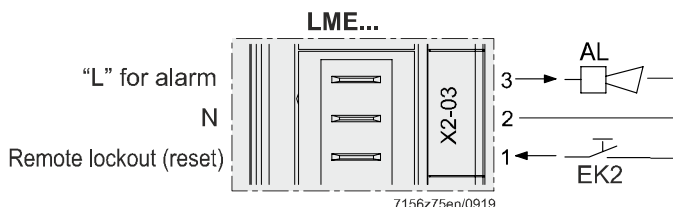

Figure 197: Alarm / remote lockout reset terminal X2-03

8.2.1 Alarm terminal X2-03 pin 3

Output at terminal X2-03 pin 3 for connecting an alarm lamp or horn. The output is activated when the LME76 is in the lockout position.



Exception!

The output is deactivated (alarm lamp OFF), when the LME76 is in the lockout position (lockout code Loc: 10) due to an error in the output contacts (welded contact of an output relay).

8.2.1 Remote lockout reset (reset) terminal X2-03 pin 1

Input at terminal X2-03 pin 1 for connecting a lockout reset button between pin 2 and pin 1. The LME76 can be reset with this button (non-alterable lockout position). Press and hold the button for >1...<3 seconds to reset.

8.3 Actuator terminal X2-09

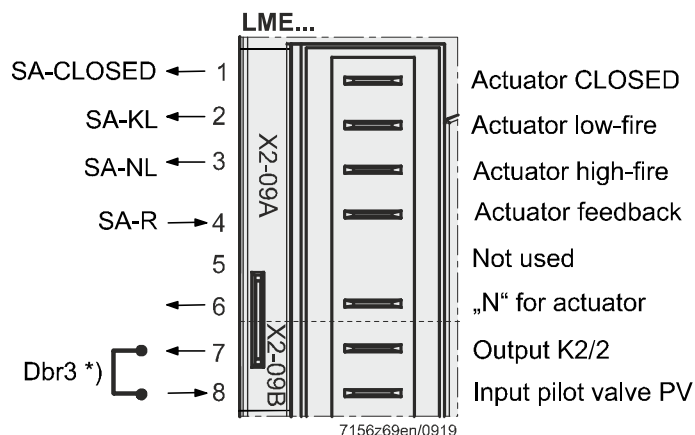

*) The wire link Dbr3 must be connected if there is no actuator

Figure 20: Actuator terminal X2-09

Parameter	Function
123	Minimum load control step
212	Running time of the actuator to the low-fire position on shutdown 0 seconds: Shutdown in the final actuator position > 0 seconds: Actuator travels to low-fire position → shutdown takes place
259	Opening time of actuator (timeout)
260	Closing time of actuator (timeout)
515.00	Actuator position during prepurge time (not adjustable) 1 = purging in high-fire
515.01	Actuator control 0 = OFF 1 = ON
	<p>Note! Setting = 0 No actuators may be connected and parameter 560 must be set to 0. The wire link Dbr3 is also required between terminal X2-09B pin 7 and terminal X2-09B pin 8.</p>
560	Pneumatic combustion control 0 = OFF / 3-position step modulation 1 = PWM fan motor / analog modulation
	<p>Note! Setting = 1 No function. This selection puts the LME76 in lockout position.</p>
	2 = Air damper / analog modulation (ASZxx.3x feedback required)
654	Only with analog modulating (parameter 560 = 2) Analog input (ASZxx.3x feedback required) 0 = 3-position step input 1 = 0...10 V 2 = 0...135 Ω 3 = 0...20 mA 4 = 4...20 mA with a non-alterable lockout at I < 4 mA 5 = 4...20 mA without a non-alterable lockout at I < 4 mA

The actuators are powered by mains voltage delivered directly via the LME76.

8.3.1 Connection of feedback actuator position with ASZ in actuator at terminal X66

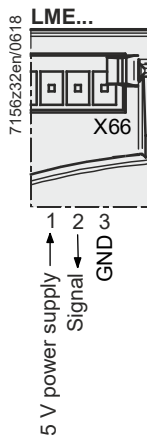

Figure 21: Actuator terminal X66

Type	Terminal X66			Direction of rotation	
	Pin 1 (5 V signal)	Pin 2 (Signal)	Pin 3 (GND)	Clockwise	Counterclockwise
ASZ	a	b	c	•	---
ASZ	c	b	a	---	•

Terminal ASZxx30
(1 kΩ conductive plastic 90°)

8.3.2 Engineering notes

Connection diagram

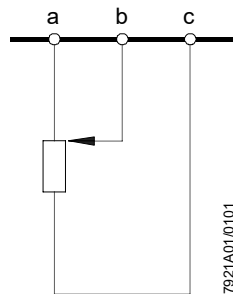

ASZ shown in start position.

Terminal markings:
a = potentiometer end tap
b = potentiometer wiper
c = potentiometer end tap

Figure 22: ASZ connection diagram

Apply operating voltage to “a” and “c”.
Conductive plastic ASZ units can be destroyed if operating voltage is applied between “a → b” or “b → c”.

8.3.3 Pin assignment of actuators for terminals X2-09 and X7-02

at LME76

8.3.3.1. SQN70/SQN71

→ See diagram 6 in SQN70/SQN71 data sheet N7804

Terminal X2-09			Actuator		
Pin	Function	Wire link	Pin	Cam	Function
1	Travel to CLOSED position	1 to 2	2	II	Low-fire
2	Travel to low-fire position	1 to 2			
3	Travel to high-fire position		1	I	High-fire
4	Feedback high-fire position / low-fire position / ignition load position		5	---	Feedback
5	Free		---	---	---
6	Mains connection neutral (N)		N	---	Neutral
7	Pilot valve output (power supply)	7 to 8	---	---	---
8	Pilot valve control and feedback	7 to 8	---	---	---
Terminal X7-02					
3	Travel to ignition load position		4	III	Ignition load

8.3.3.2. SQN72

→ See diagram C in SQN72 data sheet N7802

Terminal X2-09			Actuator		
Pin	Function	Wire link	Pin	Cam	Function
1	Travel to CLOSED position	1 to 2	X2-2	II	Low-fire
2	Travel to low-fire position	1 to 2			
3	Travel to high-fire position		X2-1	I	High-fire
4	Feedback high-fire position / low-fire position / ignition load position		X2-5	---	Feedback
5	Free		---	---	---
6	Mains connection neutral (N)		X2-N	---	Neutral
7	Pilot valve output (power supply)	7 to 8	---	---	---
8	Pilot valve control and feedback	7 to 8	---	---	---
Terminal X7-02					
3	Travel to ignition load position		X1-4	III	Ignition load

8.3.3.3. SQM5

→ See diagram in SQM5 data sheet N7815

Terminal X2-09			Actuator		
Pin	Function	Wire link	Pin	Cam	Function
1	Travel to CLOSED position	1 to 2	2	II	Low-fire
2	Travel to low-fire position	1 to 2			
3	Travel to high-fire position		1	I	High-fire
4	Feedback high-fire position / low-fire position / ignition load position		11	---	Feedback
			22		
			23		
5	Free		---	---	---
6	Mains connection neutral (N)		N	---	Neutral
7	Pilot valve output (power supply)	7 to 8	---	---	---
8	Pilot valve control and feedback	7 to 8	---	---	---
Terminal X7-02					
3	Travel to ignition load position		3	III	Ignition load

8.3.3.4. SQM40/SQM41

→ See diagram 8 in SQM40/SQM41 data sheet N7817

Terminal X2-09			Actuator		
Pin	Function	Wire link	Pin	Cam	Function
1	Travel to CLOSED position	1 to 2	X1-5	II	Low-fire
2	Travel to low-fire position	1 to 2			
3	Travel to high-fire position		X1-6	I	High-fire
4	Feedback high-fire position / low-fire position / ignition load position		X2-3	---	Feedback
5	Free		---	---	---
6	Mains connection neutral (N)		X1-4	---	Neutral
7	Pilot valve output (power supply)	7 to 8	---	---	---
8	Pilot valve control and feedback	7 to 8	---	---	---
Terminal X7-02					
3	Travel to ignition load position		X1-1	III	Ignition load

→ Fuel train **Gp1/1** "Gas pilot ignition, 1-stage, modulating"

Example 1: LME76.000Ax with SQM40/SQM41 and ASZ

→ See diagram 8 in SQM40/SQM41 data sheet N7817



Note!
For other possible gas trains, see chapter *Fuel trains*.

LME76.000...
X7-01 | X7-04

1	2	3	1	2	3	4
PE	N	L	PE	N	L	L
PV			V1			

LME76.000...
X2-09

1	2	3	4	5	6	7	8
SA-CLOSED	SA-KL	SA-NL	SA-R	PE	N	Output K2/2	Input PV

Dbr3

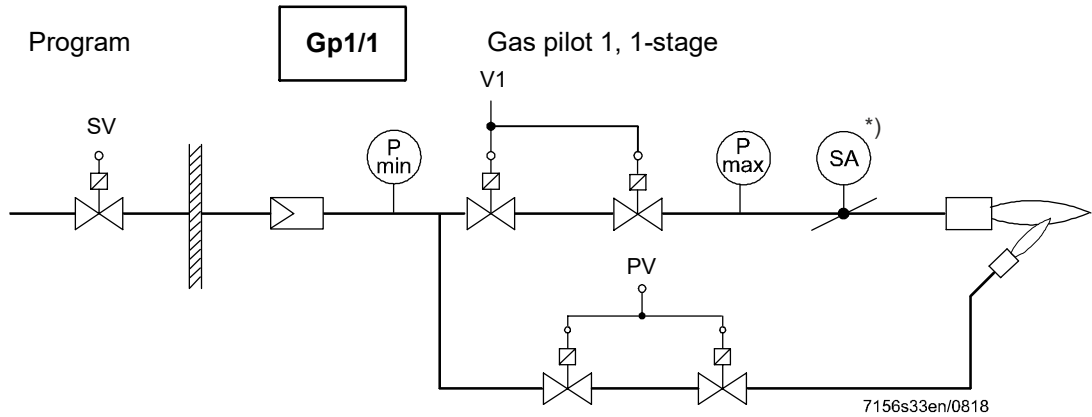

Fuel valve control

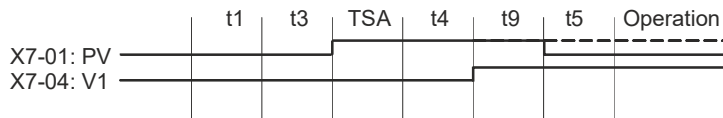

Figure 23: Example 1: Fuel train gas pilot ignition 1 (Gp1/1), 1-stage or modulating

*) Optional

Legend

- Parameter 247 = 1
- - - - - Parameter 247 = 0



Note!
See Figure 24: Connection *diagram example 1: LME76.000Ax with SQM40/SQM41 (diagram 8) and ASZ.*

PME76.812Ax

- 1-stage modulating
- With/without pilot ignition

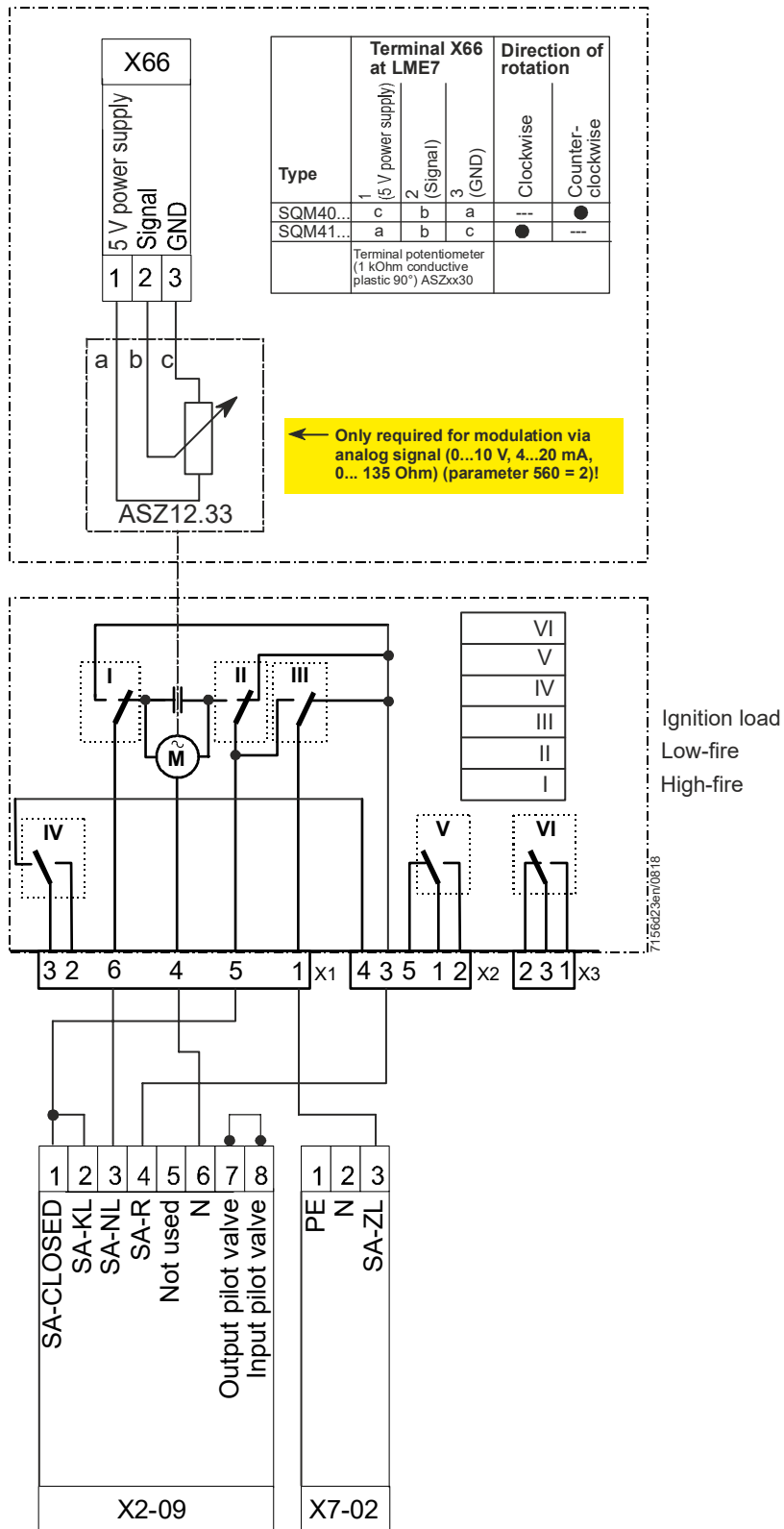

Figure 24: Connection diagram example 1: LME76.000Ax with SQM40/SQM41 (diagram 8) and ASZ

→ Fuel train **Gp1/1** "Gas direct ignition or pilot ignition, 1-stage"

Example 2: LME76.000Ax with PME76.812Ax without actuator



Note
Operation without actuator control (parameter 515.01 = 0)!
A Dbr3 wire link is required at terminal X2-09B from pin 7 to pin 8 required.

PME76.812Ax

- 1-stage, direct ignition or pilot ignition
- Without actuator

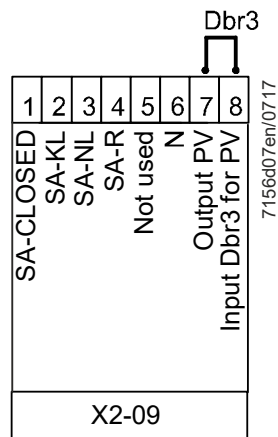

Figure 25: Connection diagram example 2: LME76.000Ax with PME76.812Ax without actuator

The actuator function can be deactivated using parameter 515.01.

Parameter access OEM level

Parameter 515.01 = 0

Actuator deactivated (setting for applications without actuator).

Parameter 515.01 = 1

Actuator activated

The following conditions must be observed for the PME76.812Ax program sequence with the actuator function deactivated:

- Wire link Dbr3 required between terminal X2-09 pin 7 and terminal X2-09 pin 8
- The parameter (pneumatic ratio control operating mode) parameter 560 = 0
- If an input signal is present at the 3-position step inputs for load controller ON at terminal X5-03 pin 3 or load controller CLOSED at terminal X5-03 pin 2, a mains voltage signal is issued at the actuator high-fire terminal X2-09 pin 3 and actuator low-fire terminal X2-09 pin 2 outputs, see table below:

Output request		Actuator control response	
Load controller OPEN (Terminal X5-03 pin 3)	Load controller CLOSED (Terminal X5-03 pin 2)	Actuator low-fire (Terminal X2-09 pin 2)	Actuator high-fire (Terminal X2-09 pin 3)
OFF	OFF	OFF	OFF
OFF	ON	ON	OFF
ON	OFF	OFF	ON
ON	ON	ON (prio)	OFF



Warning!

In applications without an actuator, no other components may be connected at the actuator control outputs (terminal X2-09 pin 1...4). To ensure protection against electric shock hazards, all unused connections must be fitted with corresponding AGG plugs (see basic documentation LME75/LME76 (P7156) chapters *Safety notes* and *Installation notes*).



Note

Operation without actuator control (parameter 515.01 = 0)!
A Dbr3 wire link is required at terminal X2-09B from pin 7 to pin 8 required.

8.4 Ignition transformer terminal X4-02

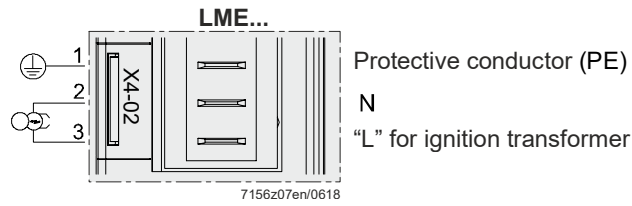

Figure 26: Ignition transformer terminal X4-02

Parameter	Function
257	Postignition time + 0.3 seconds

Output for the connection of ignition transformers or electronic ignition modules.

8.5 Safety valve terminal X6-03

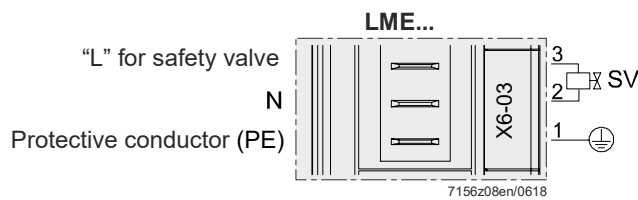

Figure 27: Safety valve terminal X6-03

Output for connection of a safety valve, e.g., for liquefied gas.



Note!

The safety valve is only active if a heat request (load controller ON/OFF) is present at terminal X5-01 pin 3.

8.6 Pilot valve PV terminal X7-01

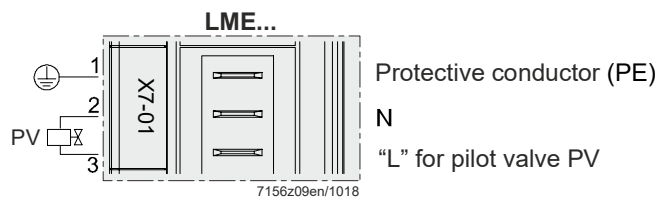

Figure 28: Pilot valve PV terminal X7-01

Parameter	Function
230	Interval (t4): Stabilization time pilot flame
231	Interval (t9): Second safety time
232	Interval (t5): Stabilization time main flame
247	Continuous pilot 0 = pilot valve until end of second safety time 1 = continuous pilot during operation

Output for connection of the pilot valve, depending on the fuel train selected.

8.7 Fuel valve V1 terminal X7-04

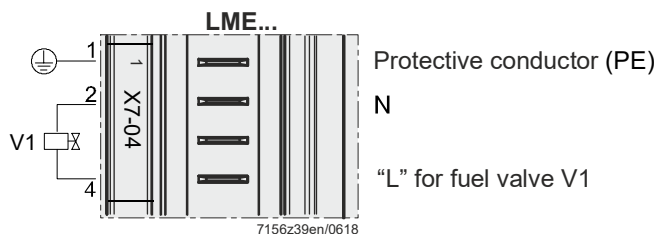

Figure 29: Fuel valve V1 terminal X7-04

Parameter	Function
230	Interval (t4): Stabilization time pilot flame
231	Interval (t9): Second safety time
232	Interval (t5): Stabilization time main flame

Output for connection of fuel valve depending on the fuel train selected.

8.8 Actuator ignition load position terminal X7-02

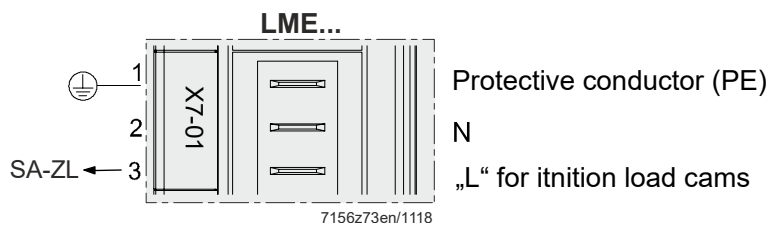

Figure 30: Actuator ignition load position terminal X7-02

Output for connection of ignition load cams of the actuator.



Note!

See Figure 24 "Connection diagram example 1: LME76.000Ax with SQM40/SQM41 (diagram 8) and ASZ".

9 Timetable and settings

Times in seconds														
Parameter			225.00	225.01	257	230	232	234.00	234.01	231	224	259	260	
Type PME76.812Ax	tw	TSA	t1		t3n	t4	t5	t8		t9	t10	t11	t12	t22 1) / 3)
		max.	min.		approx.	min.	min.	min.		approx.	approx.	approx.	approx.	
Requirements	2.5	5	30		4.4	3	2	15		10	14	60	60	t9+217.01
Factory setting	---	t3n+0.45	29.106+2.1	1	4.116+0.3	3.234	2.058	19.404	1	9.996	13.818	58.212	58.212	---
Max.	2.5	14	1237+2.1	255	13.23+0.3	74.97	74.97	1237	255	74.97	13.818	1237	1237	---
Min.	---	---	0+2.1	1	0+0.3	0	2.058	0	1	0	0	0	0	---
Increment	---	---	4.851	1	0.147	0.294	0.294	4.851	1	0.294	0.294	4.851	4.851	---

Times in seconds				
Parameter			217.01	217.01
Type PME76.812Ax			ION FFRT (TSB)	LFS1.1 FFRT (TSB)
	2)	3)	max.	max.
Requirements	---	---	1	2 *)
Factory setting	---	---	1.911 + 1	1.911 + 2
Max.	0.45	0.45	13.818 + 1	13.818 + 2
Min.	0.3	---	---	---
Increment	---	---	0.147	0.147





*)

Note!
 Maximum response time in the event of loss of flame!
 Parameter 217.01 = 0 seconds (no factory setting)
 The maximum response time in the event of a flame fault at the LFS1 input can be up to 2 seconds (typically 1.2 seconds). For applications subject to the standard response time in the event of loss of flame of ≤ 1 second, this results in the limit value being exceeded. The LME76 with LFS1 cannot be used in these applications.

Parameter number	Function	Factory setting
212	Running time of the actuator to the low-fire position on shutdown 0 seconds: Shutdown in the final actuator position > 0 seconds: Actuator travels to low-fire position → shutdown takes place	58.212 s
216	Extraneous light tolerance time in standby	30 s
217.01	Flame signal flame-out response time (extension) 0 = maximum 1 second with ionization probe, maximum 2 seconds with LFS1 ≥ 0 = additional extension to response to a flame fault	1.911 s
218	Time for controlled intermittent operation	80050.31 s
222	Prepurging 0 = inactive 1 = active	1
223	Gas pressure switch-min – response to loss 0 = safety shutdown and start prevention 1 = non-alterable lockout	1
224	Air pressure switch → specified time	13.818 s
225.00	Prepurge time (t1)	30 s
225.01	Multiplicator of the prepurge time (t1) (extension of prepurge time)	1
230	Interval (t4): Stabilization time pilot flame	3.234 s
231	Interval (t9): Second safety time	9.996 s
232	Interval (t5): Stabilization time main flame	2.058 s
234.00	Postpurge time (t8) (no extraneous light test)	19.404 s
234.01	Multiplicator of postpurge time (t8) (extension of postpurging)	1
235.00	Air pressure switch input 0 = no evaluation of the air pressure switch during operation (evaluation only during prepurging and, if necessary, postpurging) 1 = evaluation of the air pressure switch during prepurging and postpurging, as well as when in the operating position	1
235.01	Air pressure switch – response time to loss 0 = typically 0.7 seconds ≥ 0 = additional delay in response to faulty air pressure switch	0.294 s
236	Input pressure switch-min 0 = permanent evaluation 1 = in operation only (after second safety time)	0

Parameter number	Function	Factory setting
237.00	<p>Input for POC</p> <p>0 = inactive → Input does not need to be connected</p> <p>1 = active (test during startup and shutdown (not safety relevant)) → POC is checked for closed during startup and shutdown. This means that the POC can be replaced with a wire link Dbr1.</p> <p>2 = active (test during startup and shutdown, as well as when switching to operating mode (safety relevant)) → POC is checked for closed during startup and shutdown and checked for open when switching to operating mode. This means that a signal change must take place by switching the POC.</p>	1
237.01	<p>Function input for gas pressure switch-max terminal X9-04</p> <p>0 = inactive</p> <p>1 = active</p>	0
239	<p>Controlled intermittent operation after 24 hours of continuous operation</p> <p>0 = OFF</p> <p>1 = ON</p>	0
240	<p>Restart in the event of loss of flame during operation and in the event of no flame at the end of the safety time</p> <p>0 = no restart</p> <p>1 = no restart</p> <p>2 = 1x restart</p> <p>3 = 2x restart</p> <p>4 = 3x restart</p>	0
247	<p>Continuous pilot</p> <p>0 = pilot valve until end of second safety time</p> <p>1 = continuous pilot during operation</p>	0
257	Postignition time + 0.3 seconds	4.116 s
259	Opening time of actuator (timeout)	58.212 s
260	Closing time of actuator (timeout)	58.212 s

515.00	Actuator position during prepurge time (not adjustable) 1 = purging in high-fire	1
515.01	Actuator control 0 = OFF 1 = ON  <p>Note! Setting = 0 No actuators may be connected and parameter 560 must be set to 0. The wire link Dbr3 is also required between terminal X2-09B pin 7 and terminal X2-09B pin 8.</p>	1
560	Pneumatic combustion control 0 = OFF / 3-position step modulation 1 = PWM fan motor / analog modulation  <p>Note! Setting = 1 No function. This selection puts the LME76 in lockout position.</p> <p>2 = Air damper / analog modulation (ASZxx.3x feedback required)</p>	2
654	Only with analog modulating (parameter 560 = 2) Analog input (ASZxx.3x feedback required) 0 = 3-position step input 1 = 0...10 V 2 = 0...135 Ω 3 = 0...20 mA 4 = 4...20 mA with a non-alterable lockout at I < 4 mA 5 = 4...20 mA without a non-alterable lockout at I < 4 mA	1

Key

FFRT	Flame failure response time
tw	Waiting time
TSA	Startup safety time
TSB	Operation safety time
t1	Prepurge time
t3n	Postignition time parameter 257 +0.3 seconds
t4	Interval (t4): Stabilization time pilot flame
t5	Interval (t5): Stabilization time main flame
t8	Postpurge time
t9	Interval (t9): Second safety time
t10	Specified time air pressure switch message (timeout)
t11	Opening time of actuator (timeout)
t12	Closing time of actuator (timeout)
t22	Second safety time
1)	Response time to a change of signal by the air pressure switch contact (opens) and flame-out response time in the event of loss of flame
2)	Response time to a change of signal by the inputs (e.g., pressure switch-min)
3)	Flame detection time

10 Inputs and outputs / internal connection diagram

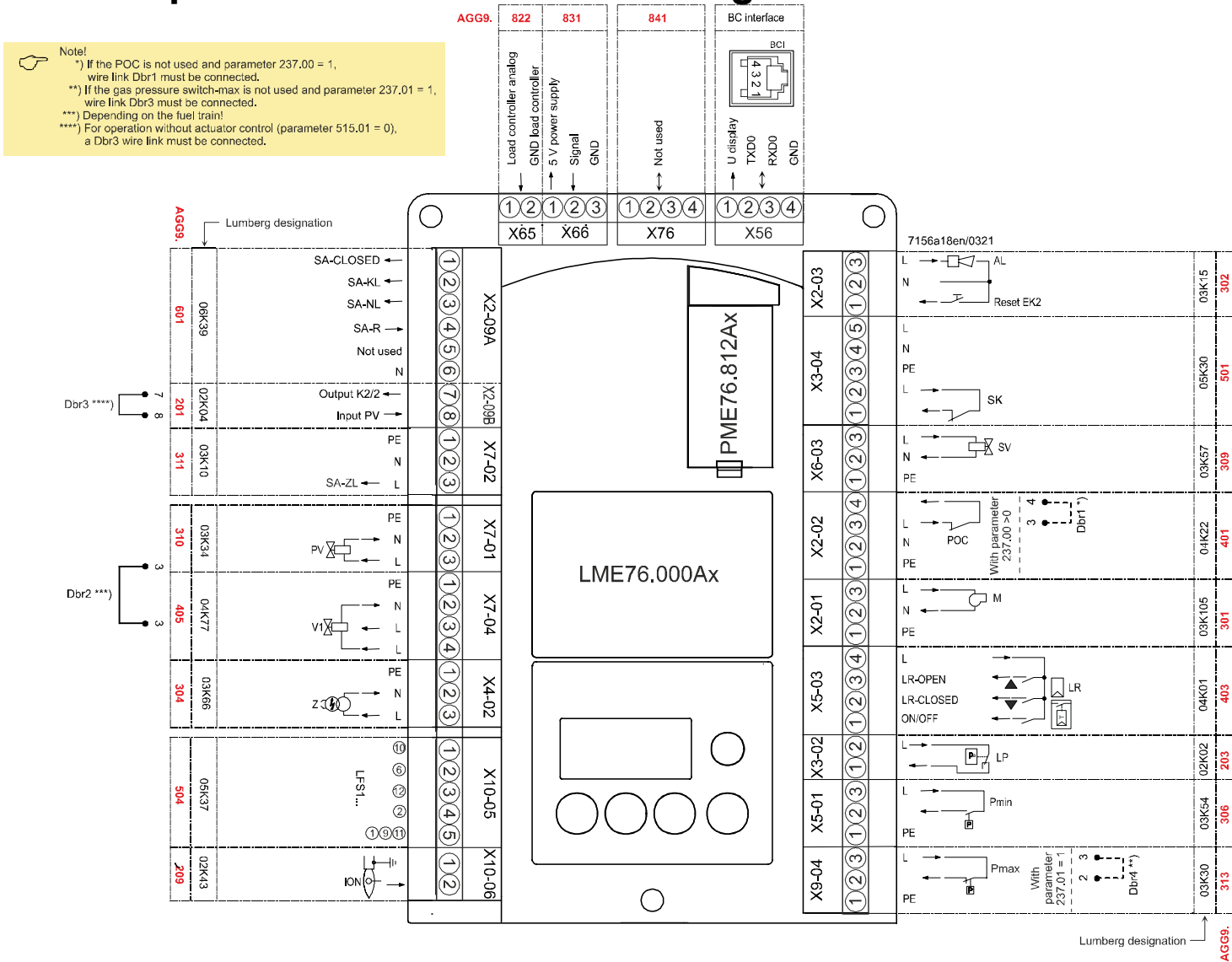

Figure 31: LME76.000Ax: Inputs and outputs / internal connection diagram

11 Parameter list (AZL2/ACS410)

Abbreviations for password level:

HF	Heating engineer
OEM	Manufacturer of the original product



Parameter number	Function	Edit	Value range		Increment	Factory setting	Password level reading from level	Password level writing from level
			Min.	Max.				
000	Internal parameters							
041	Heating engineer (HF) password (4 characters)	Adjustable	xxxx	xxxx	---	On request	---	OEM
042	OEM password (5 characters)	Adjustable	xxxxx	xxxxx	---	On request	---	OEM
060	Backup/Restore	Adjustable	Restore	Backup	---	---	---	HF

Parameter number	Function	Edit	Value range		Increment	Factory setting	Password level reading from level	Password level writing from level
			Min.	Max.				
100	General							
101	Type (ASN) of the basic unit	Read only	xxxxx.xxxxx	xxxxx.xxxxx	---	---	Via ACS410 only	---
102	Identification date	Read only	---	---	---	---	Info	---
103	Identification number	Read only	0	9999	1	0	Info	---
113	Burner identification • Can be read via AZL2 • Can be adjusted via ACS410	Read only/selectable	0	99999999	1	-----	Info	OEM via ACS410
119	Type of OEM program module	Read only	xxxxx.xxxxx	xxxxx.xxxxx	--	PME76.812Ax	Via ACS410 only	---
120	Type of program module	Read only	xxxxx.xxxxx	xxxxx.xxxxx	--	PME76.812Ax	Via ACS410 only	---
123	Minimum load control step	Adjustable	1%	10%	0.1%	2%	HF	HF
140	Mode display in the 7-segment display 1 = standard (program phase) 2 = flame 1 (ionization) 3 = flame 2 (LFS1) 4 = active power (power value)	Adjustable	1	4	1	1	HF	HF
164	Number of startups	Resettable	0	999999	1	0	Info	Info
166	Total number of startups	Read only	0	999999	1	0	Info	---
170.00	Relay contact K8 switching cycles (SA-KL: X2-09 pin 2)	Read only	0	99999999	1	0	Info	---
170.01	Relay contact K7 switching cycles (SA-NL: X2-09 pin 3)	Read only	0	99999999	1	0	Info	---
170.02	Relay contact K2 switching cycles (PV: X7-01 pin 3)	Read only	0	99999999	1	0	Info	---
170.03	Relay contact K1 switching cycles (SV: X6-03 pin 3)	Read only	0	99999999	1	0	Info	---
171	Signaling of "Switching cycle exceeded" for one of the relay contact counters (parameters 170.00 to 170.03) → not active	Read only	0	99999999	1	1000000	Info	---
179	Logical combination of both flame signal amplifier channels 0 = flame signal amplifier channels are logically combined with an OR operation (ionization OR LFS1) 1 = flame signal amplifier channels are logically combined with an AND operation (ionization AND LFS1)	Adjustable	0	1	1	0	HF	OEM
180	No function	Adjustable	0	1	1	0	HF	OEM

Parameter number	Function	Edit	Value range		Increment	Factory setting	Password level reading from level	Password level writing from level
			Min.	Max.				
200	Burner control LME76							
212	Running time of the actuator to the low-fire position on shutdown 0 seconds: Shutdown in the final actuator position > 0 seconds: Actuator travels to low-fire position → shutdown takes place	Adjustable	0 s	1237 s	4.851 s	58.212 s	HF	HF
216	Extraneous light tolerance time in standby	Adjustable	0 s	1237 s	4.851 s	29.106 s	HF	HF
217.00	Flame signal flame-on response time (extension) (not adjustable) 0 = maximum 1 second with ionization probe, maximum 2 seconds with LFS1	Read only	0 s	0 s	0.147 s	0 s	HF	---
217.01	Flame signal flame-out response time (extension) 0 = maximum 1 second with ionization probe, maximum 2 seconds with LFS1 ≥ 0 = additional extension to response to a flame fault	Adjustable	0 s	13.818 s	0.147 s	1.911 s	HF	OEM
218	Time for controlled intermittent operation	Adjustable	0 s	80050.31 s	358.97 s	80050.31 s	HF	OEM
222	Prepurging 0 = inactive 1 = active	Adjustable	0	1	1	1	HF	HF
223	Gas pressure switch-min – response to loss 0 = safety shutdown and start prevention 1 = non-alterable lockout	Adjustable	0	1	1	1	HF	HF
224	Specified time air pressure switch	Adjustable	0 s	13.818 s	0.294 s	13.818 s	HF	OEM
225.00	Prepurge time (t1)	Adjustable	0 s	1237 s	4.851 s	29.106 s	HF	OEM
225.01	Multiplicator of the prepurge time (t1) (extension of prepurge time)	Adjustable	1	255	1	1	HF	OEM
230	Interval (t4): Stabilization time pilot flame	Adjustable	0 s	74.97 s	0.294 s	3.234 s	HF	OEM
231	Interval (t9): Second safety time	Adjustable	0 s	74.97 s	0.294 s	9.996 s	HF	OEM
232	Interval (t5): Stabilization time main flame	Adjustable	2.058 s	74.97 s	0.294 s	2.058 s	HF	OEM
234.00	Postpurge time (t8) (no extraneous light test)	Adjustable	0 s	1237 s	4.851 s	19.404 s	HF	HF
234.01	Multiplicator of postpurge time (t8) (extension of postpurging)	Adjustable	1	255	1	1	HF	HF

Parameter number	Function	Edit	Value range		Increment	Factory setting	Password level reading from level	Password level writing from level
			Min.	Max.				
235.00	Air pressure switch input 0 = no evaluation of the air pressure switch during operation (evaluation only during prepurging and, if necessary, postpurging) 1 = evaluation of the air pressure switch during prepurging and postpurging, as well as when in the operating position	Adjustable	0	1	1	1	HF	HF
235.01	Air pressure switch – response time to loss 0 = typically 0.7 seconds ≥ 0 = additional delay in response to faulty air pressure switch	Adjustable	0 s	2.058 s	0.147 s	0.294 s	HF	HF
236	Input pressure switch-min 0 = permanent evaluation 1 = in operation only (after second safety time)	Adjustable	0	1	1	0	HF	HF
237.00	Input for POC 0 = inactive → Input does not need to be connected 1 = active (test during startup and shutdown (not safety relevant)) → POC is checked for closed during startup and shutdown. This means that the POC can be replaced with a wire link Dbr1. 2 = active (test during startup and shutdown, as well as when switching to operating mode (safety relevant)) → POC is checked for closed during startup and shutdown and checked for open when switching to operating mode. This means that a signal change must take place by switching the POC.	Adjustable	0	2	1	1	HF	HF
237.01	Function input for gas pressure switch-max terminal X9-04 0 = inactive 1 = active	Adjustable	0	1	1	0	HF	OEM
239	Controlled intermittent operation after 24 hours of continuous operation 0 = OFF 1 = ON	Adjustable	0	1	1	0	HF	OEM

Parameter number	Function	Edit	Value range		Increment	Factory setting	Password level reading from level	Password level writing from level
			Min.	Max.				
240	Restart in the event of loss of flame during operation and in the event of no flame at the end of the safety time 0 = no restart 1 = no restart 2 = 1x restart 3 = 2x restart 4 = 3x restart	Adjustable	0	4	1	0	HF	HF
247	Continuous pilot 0 = pilot valve until end of second safety time 1 = continuous pilot during operation	Adjustable	0	1	1	0	HF	OEM
257	Postignition time + 0.3 seconds	Adjustable	0 s	13.23 s	0.147 s	4.116 s	HF	OEM
259	Opening time of actuator (timeout)	Adjustable	0 s	1237 s	4.851 s	58.212 s	HF	OEM
260	Closing time of actuator (timeout)	Adjustable	0 s	1237 s	4.851 s	58.212 s	HF	OEM

Parameter number	Function	Edit	Value range		Increment	Factory setting	Password level reading from level	Password level writing from level
			Min.	Max.				
500	Ratio control							
515.00	Actuator position during prepurge time (not adjustable) 1 = purging in high-fire	Read only	0	1	1	1	HF	---
515.01	Actuator control 0 = OFF 1 = ON  <div style="background-color: yellow; padding: 5px; margin-top: 5px;"> <p>Note! Setting = 0 No actuators may be connected and parameter 560 must be set to 0. The wire link Dbr3 is also required between terminal X2-09B pin 7 and terminal X2-09B pin 8.</p> </div>	Adjustable	0	1	1	1	HF	OEM
560	Pneumatic combustion control 0 = OFF / 3-position step modulation 1 = PWM fan motor / analog modulation  <div style="background-color: yellow; padding: 5px; margin-top: 5px;"> <p>Note! Setting = 1 No function. This selection puts the LME76 in lockout position.</p> </div> 2 = Air damper / analog modulation (ASZxx.3x potentiometer feedback required)	Adjustable	0	2	1	2	HF	HF

Parameter number	Function	Edit	Value range		Increment	Factory setting	Password level reading from level	Password level writing from level
			Min.	Max.				
600	Power setting							
654	Only with analog modulating (parameter 560 = 2) Analog input (ASZxx.3x feedback required) 0 = 3-position step input 1 = 0...10 V 2 = 0...135 Ω 3 = 0...20 mA 4 = 4...20 mA with a non-alterable lockout at I < 4 mA 5 = 4...20 mA without a non-alterable lockout at I < 4 mA	Adjustable	0	5	1	1	HF	HF
700	Error history							
701	Current error: 00: Error code 01: Startup meter reading 02: MMI phase 03: Power value	Read only	2 0 --- 0%	255 999999 --- 100%	1 1 --- 1	---	Service	---
702	Latest error in the history 00: Error code 01: Startup meter reading 02: MMI phase 03: Power value	Read only	2 0 --- 0%	255 999999 --- 100%	1 1 --- 1	---	Service	---
•								
•								
•								
711	Oldest error in the history 00: Error code 01: Startup meter reading 02: MMI phase 03: Power value	Read only	2 0 --- 0%	255 999999 --- 100%	1 1 --- 1	---	Service	---





Parameter number	Function	Edit	Value range		Increment	Factory setting	Password level reading from level	Password level writing from level
			Min.	Max.				
900	Process data							
903	Modulating operation: Current output (0...100% in 1% increments)	Read only	0%	100%	1%	---	Via ACS410 only	---
908	Target fan speed (standardized)	Read only	0%	100%	1%	---	Via ACS410 only	---
920	Current signal of PWM fan motor	Read only	0%	100%	1%	---	Service	---
922	Position of the actuators	Read only	0%	100%	1%	---	Via ACS410 only	---
923	Target position of the actuators	Read only	0%	100%	1%	---	Via ACS410 only	---
935	Absolute speed of PWM fan motor	Read only	0	9999	rpm	---	Service	---
936	Standardized speed of PWM fan motor	Read only	0%	100%	0.01%	---	Service	---
944	Output of the external load controller	Read only	0%	100%	1%	---	Via ACS410 only	---
951	Mains voltage	Read only	0 V	LME76.000A1: 175 V LME76.000A2: 350 V	1 V	---	Service	---
954.00	Intensity of flame for ionization probe (0...100%)	Read only	0%	100%	1%	---	Service	---
954.01	Intensity of flame LFS1 (0% or 100%)	Read only	0%	100%	100%	---	Service	---

12 Error code list

Error code		Plain text	Possible cause
AZL2	LED display (alternating)		
Loc: 2	Loc 2	No flame at end of safety time	<ul style="list-style-type: none"> Faulty or soiled fuel valves Defective, soiled or incorrectly connected flame detector Poor adjustment of burner, no fuel Faulty ignition
Loc: 3	Loc 3	Air pressure faulty (air pressure switch welded in no-load position, decrease to specified time) (air pressure switch flame-on response time)	Air pressure switch faulty <ul style="list-style-type: none"> Loss of air pressure signal after specified time Air pressure switch welded in no-load position
Loc: 4	Loc 4	Extraneous light	Extraneous light during burner startup / standby or after extraneous light tolerance time has elapsed (parameter 216) in standby
Loc: 5	Loc 5	Air pressure faulty, air pressure switch welded in operating position	Time supervision air pressure switch <ul style="list-style-type: none"> Air pressure switch welded in operating position
Loc: 6	Loc 6	Actuator fault	<ul style="list-style-type: none"> Actuator faulty or blocked Faulty connection Faulty adjustment
Loc: 7	Loc 7	Loss of flame	Too many losses of flame during operation (limitation of restarts) <ul style="list-style-type: none"> Faulty or soiled fuel valves Faulty or soiled flame detector Poor adjustment of burner
Loc: 10	Loc 10	Non-volatile lockout with alarm output switched on at terminal X2-03 pin 3 (fault lamp ON)	Wiring error or internal error, other errors
Loc: 10	Loc 10	Non-volatile lockout with alarm output switched off at terminal X2-03 pin 3 (fault lamp OFF)	Output contact error (welded contact of an output relay)
Loc: 14	Loc 14	POC fault	Fault valve closing control POC
Loc: 20	Loc 20	Gas pressure switch-min open	Gas shortage
Loc: 21	Loc 21	Gas pressure switch-max open	Gas pressure has exceeded maximum limit
Loc: 22	Loc 22	Safety loop open	<ul style="list-style-type: none"> External limit thermostat or pressure switch open Safety temperature limiter has tripped
Loc: 31	Loc 31	Flame safeguard test failed	External flame safeguard faulty

Error code		Plain text	Possible cause
AZL2	LED display (alternating)		
Loc: 60	Loc 60	Analog load controller source 4... 20 mA, I < 4 mA	Wire breakage
Loc: 138	Loc 138	Restore process successful	Restore process successful
Loc: 139	Loc 139	No PME76 detected	No PME76 plugged in
Loc: 167	Loc 167	Manual locking	Manual locking
Loc: 206	Loc 206	AZL2 incompatible	Use the latest version
rSt Er1	rSt Er1	Error in compatibility between PME76 and LME76 during restore process	Program sequence of PME76 does not match the LME76
rSt Er2	rSt Er2	Error in compatibility between PME76 and LME76 during restore process	LME76 hardware does not match the PME76
rSt Er3	rSt Er3	Error during restore process	<ul style="list-style-type: none"> • PME76 faulty • PME76 removed during restore process
bAC Er3	bAC Er3	Error in compatibility between PME76 and LME76 during backup process	Program sequence of PME76 does not match the LME76
Err PrC	Err PrC	Fault in PME76	<ul style="list-style-type: none"> • Error in data content of the PME76 • No PME76 plugged in

13 Key

AL	Alarm device
Dbr...	Wire link
	Lockout reset button (info button)
 reset (EK1)	
EK2	Remote lockout reset button
FSV	Flame signal amplifier
ION	Ionization probe
Kx	Relay contact
LED	3-color signal lamp
LFS1	Flame safeguard
LP	Air pressure switch
LR	Load controller
LR-OPEN	Load controller OPEN position
LR-CLOSED	Load controller CLOSED position
M	Fan motor
NT	Power supply unit
Pmax	Pressure switch-max
Pmin	Pressure switch-min
POC	Valve closing control (proof of closure)
PV	Pilot valve
R	Control thermostat or pressurestat
SA	Actuator
SA-KL	Actuator low-fire
SA-NL	Actuator high-fire
SA-R	Actuator feedback
SA-CLOSED	Actuator CLOSED
SA-ZL	Actuator ignition load
SK	Safety loop
SV	Safety valve
V1	Fuel valve
V2	Fuel valve
Z	Ignition transformer
	Input/output signal 1 (ON)
	Input/output signal 0 (OFF)
	Permissible signal 1 (ON) or 0 (OFF)

14 Table of Figures

Figure 1: Program sequence for fuel trains G and Gp1/1	7
Figure 2: Program sequence for fuel trains G and Gp1/1	8
Figure 3: Fuel train gas direct ignition (G), 1-stage	10
Figure 4: Fuel train gas pilot ignition 1 (Gp1/1), 1-stage.....	11
Figure 5: Air pressure switch terminal X3-02.....	12
Figure 6: Gas pressure switch-min terminal X5-01.....	16
Figure 7: POC terminal X2-02	18
Figure 8: Gas pressure switch-max terminal X9-04.....	19
Figure 9: Ionization probe terminal X10-06.....	20
Figure 10: LFS1 terminal X10-05.....	21
Figure 11: Connection diagram of an ionization probe only without LFS1	24
Figure 12: Connection diagram with LFS1	24
Figure 13: Connection diagram with 2x LFS1 in logical OR operation	25
Figure 14: Connection diagram with 2x LFS1 in logical AND operation.....	26
Figure 15: Load controller terminal X65.....	29
Figure 16: Load controller ON/OFF terminal X5-03.....	32
Figure 17: Safety loop terminal X3-04	34
Figure 18: Fan motor terminal X2-01	35
Figure 177: Alarm / remote lockout reset terminal X2-03	35
Figure 20: Actuator terminal X2-09.....	36
Figure 21: Actuator terminal X66.....	37
Figure 22: ASZ connection diagram	37
Figure 23: Example 1: Fuel train gas pilot ignition 1 (Gp1/1), 1-stage or modulating....	40
Figure 24: Connection diagram example 1: LME76.000Ax with SQM40/SQM41 (diagram 8) and ASZ	41
Figure 25: Connection diagram example 2: LME76.000Ax with PME76.812Ax without actuator.....	42
Figure 26: Ignition transformer terminal X4-02	44
Figure 27: Safety valve terminal X6-03.....	44
Figure 28: Pilot valve PV terminal X7-01	44
Figure 29: Fuel valve V1 terminal X7-04	45
Figure 30: Actuator ignition load position terminal X7-02	45
Figure 31: LME76.000Ax: Inputs and outputs / internal connection diagram	51

