

LMV36.520...

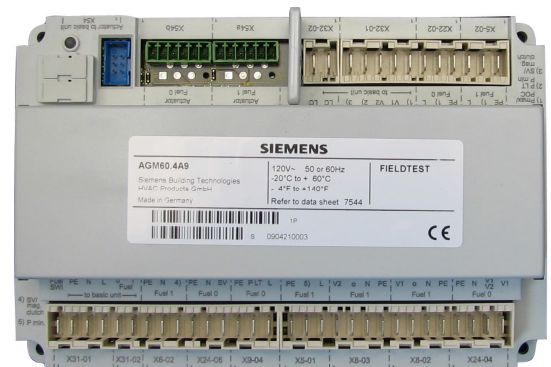

AGM60.4A9

**Basic unit with integrated fuel-air ratio control for forced draft burners**

**LMV36.520...**

**Switch unit for switching the valve control or feedback signals of both fuels**

**AGM60.4A9**

The LMV36 burner management system is a microprocessor-based burner control with matching system components for control and supervision of forced draft burners of medium to high capacity.

For the use of dual fuel application with 2 fuel actuators, the AGM60 dual fuel switch unit is required.

The LMV36 / AGM60 and this Data Sheet are intended for use by OEMs which integrate the actuators in their products!

## Use

---

Microprocessor-controlled LMV36 for single-fuel burners of any capacity, with electronic fuel-air ratio control, with up to 2 actuators, and with integrated gas valve proving.

The system components (AZL2 and actuators) are connected directly to the LMV36 in single-fuel operation. All safety-related digital inputs and outputs of the LMV36 are supervised by a contact feedback network.

The AGM60 dual fuel switch unit connected to the LMV36 is used for switching the fuel valve control and the feedback signals of both fuel actuators.

- Type-tested and approved in accordance with DIN EN 298
- Applications in accordance with EN 676: Automatic forced draft burners for gaseous fuels
- Applications in accordance with EN 267: Forced draft burners for liquid fuels

For North America

For intermittent operation in connection with the LMV36/AGM60, the ionization probe or the QRA/QRC optical flame detector can be used.

**Continuous operation is possible only when using an ionization probe and without AGM60.**

## Features

---

The following components are integrated in the LMV36:

- Burner control complete with valve proving system
- Electronic fuel / air ratio control system for a maximum of 2 actuators SQM3 or SQN1
- Control of VSD for air fan
- Modbus interface
- BCI for connection a display or PC
- Unit parameter adjustable either via display or PC software ACS410

## Notes

---



**Warning!**

**All safety, warning and technical notes given in the Basic Documentation of the LMV36 (P7544) also apply to this document!**



**Applied directives:**

- Low-voltage directive 2014/35/EU
- Directive for pressure devices 2014/68/EU
- Gas Appliances Regulation (EU) (EU) 2016/426
- Electromagnetic compatibility EMC (immunity) \*) 2014/30/EU

\*) The compliance with EMC emission requirements must be checked after the burner management system is installed in equipment

Compliance with the regulations of the applied directives is verified by the adherence to the following standards / regulations:

- Automatic burner control systems for burners and appliances burning gaseous or liquid fuels DIN EN 298
- Safety and control devices for gas burners and gas burning appliances - Valve proving systems for automatic shut-off valves DIN EN 1643
- Gas/air ratio controls for gas burners and gas burning appliances Part 2: Electronic types DIN EN 12067-2
- Safety and control devices for gas burners and gas burning appliances DIN EN 13611
- Safety and control devices for gas burners and gas-burning appliances - Particular requirements Part 1: Automatic and semi-automatic valves ISO 23552-1
- Automatic electrical controls for household and similar use Part 2-5: Particular requirements for automatic electrical burner control systems DIN EN 60730-2-5

**The relevant valid edition of the standards can be found in the declaration of conformity!**



**Note on EN 60335-2-102**

Household and similar electrical appliances – Safety

Part 2-102:

Particular requirements for gas, oil and solid-fuel burning appliances having electrical connections. The electrical connections of the LMV36 and the AGM60 comply with the requirements of EN 60335-2-102.



EAC Conformity mark (Eurasian Conformity mark)



ISO 9001:2015  
ISO 14001:2015  
OHSAS 18001:2007



China RoHS  
Hazardous substances table:  
<http://www.siemens.com/download?A6V10883536>



## Life cycle

---

LMV36	The burner management system has a designed lifetime* of 250,000 burner startup cycles which, under normal operating conditions in heating mode, correspond to approx. 10 years of usage (starting from the production date given on the type field).
AGM60	The AGM60 dual fuel switch unit has a designed lifetime* of 5,000 burner startup cycles which, under normal operating conditions in heating mode, correspond to approx. 10 years of usage (starting from the production date given on the type field).
General	<p>This lifetime is based on the endurance tests specified in standard DIN EN 298. A summary of the conditions has been published by the European Control Manufacturers Association (Afecor) (<a href="http://www.afecor.org">www.afecor.org</a>).</p> <p>The designed lifetime is based on use of the LMV36 / AGM60 according to the manufacturer's Data Sheet and Basic Documentation. When reaching the designed lifetime in terms of the number of burner startup cycles or time of usage, the LMV36 / AGM60 must be replaced by authorized personnel.</p> <p>* The designed lifetime is not the warranty time specified in the Terms of Delivery</p>

## Supplementary documentation

---

User Documentation Modbus AZL2.....	A7541
Environmental Product Declaration LMV2 / LMV3.....	E7541 *)
Environmental Product Declaration AGM60 .....	E7547 *)
Installation and Operating Instructions PC Software ACS410 .....	J7352
Basic Documentation LMV36 / AGM60 .....	P7544
Product Range Overview LMV2 / LMV3 .....	Q7541

\*) On request

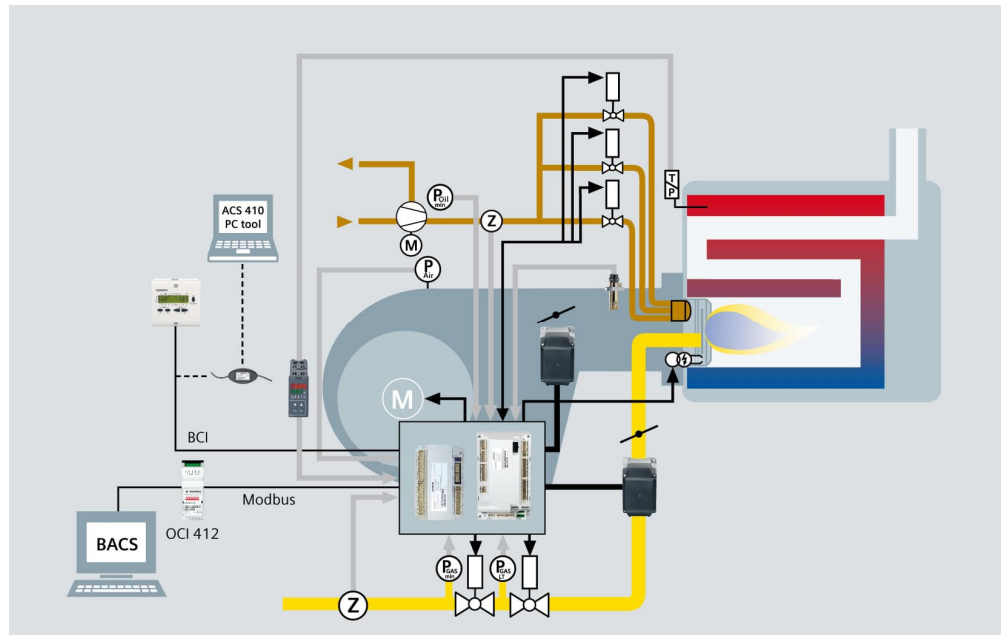

The diagram shows the full scope of functions of the LMV36. The actual functions are to be determined based on the respective execution / configuration!

## Ordering

### Burner control

#### LMV36

The basic unit is the actual burner control featuring all-polar input/output terminals. No operating elements. Operation via detached ancillary units for wire-bound communication. See Basic Documentation P7544.



Article no.	Type	Mains voltage	Parameter set	Detectors
BPZ:LMV36.520A1	LMV36.520A1	AC 120 V	North America	QRA2 / QRA4 / QRA10 / QRB / ION
S55402-C202-A100	LMV36.520A1UL	AC 120 V	US	QRA2 / QRA4 / QRA10 / QRB / ION

### Dual fuel switch unit

#### AGM60.4A9

Connected on the LMV36. Used for switching the valve control or feedback signals and actuators of both fuels. See Basic Documentation P7544.



Article no.	Type	Mains voltage
BPZ:AGM60.4A9	AGM60.4A9	AC 120 V

### Fuel selector

The fuel selector is **not** a component of the AGM60 and does **not** constitute part of the scope of delivery.

### Service tools

#### OCI410 interface between burner management system and PC

Article no.: **BPZ:OCI410**

Facilitates viewing, processing, and recording of setting parameters on site using the ACS410 PC software. See Data Sheet N7616.



#### OCI412.10 Modbus interface

Article no.: **BPZ:OCI412.10**

Device serving as an interface between the LMV36 and a Modbus system, such as a building automation and control system (BACS). The Modbus interface is based on the RS-485 standard. See Data Sheet N7615.



#### ACS410 PC software

Article no.: **BPZ:ACS410**

PC software for parameterization and visualization to the burner management system. See Software Documentation J7352.

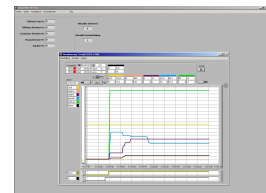

## Ordering (cont'd)

---

### Display and operating units

#### **AZL21.00A9**

Article no.: **BPZ:AZL21.00A9**

Detached display and operating unit, choice of mounting methods, 8-digit LCD, 5 buttons, BCI for LMV36, degree of protection IP40.

See Data Sheet N7542.



---

#### **AZL23.00A9**

Article no.: **BPZ:AZL23.00A9**

Detached display and operating unit, choice of mounting methods, 8-digit LCD, 5 buttons, BCI for LMV36 system, degree of protection IP54.

See Data Sheet N7542.



Flame detectors

**QRA2**

Flame detector for use with Siemens burner controls, for the supervision of gas flames and yellow- or blue-burning oil flames as well as ignition spark checking. Plastic housing, metalized to prevent static charging caused by the air flow from the fan. For direct mounting on the burner. The detectors can be supplied with or without securing flange and clamp.

See Data Sheet N7712.



**QRA4**

Flame detector for use with Siemens burner controls, for the supervision of gas flames and yellow- or blue-burning oil flames as well as for ignition spark proving.

See Data Sheet N7711.



**QRA10**

Flame detector for use with Siemens burner controls, for the supervision of gas flames and yellow- or blue-burning oil flames as well as ignition spark checking. Die-cast aluminum housing with a 1 in. mounting coupling and connection facility for cooling air. The housing of this detector has a bayonet fitting which allows it to be secured either directly to the 1 in. mounting coupling or to the AGG06. The 1 in. mounting coupling can be screwed to a viewing tube or to the AGG07. The Pg cable gland can be removed and replaced, if some other detector cable shall be used.

See Data Sheet N7712.



**QRB1**

Photo resistive flame detector for use with Siemens burner controls, for the supervision of oil flames in the visible light spectrum. Especially suited for use with burner controls for small capacity burners in intermittent operation.

See Data Sheet N7714



**QRB3**

Photo resistive flame detector for use with Siemens burner controls, for the supervision of oil flames in the visible light spectrum. Especially suited for use with burner controls for small capacity burners in intermittent operation.

See Data Sheet N7714.



**QRB4**

Yellow flame detector for use with Siemens burner controls, for the supervision of oil flames in the visible light spectrum. The QRB4 is used in connection with oil burner controls in intermittent operation.

Refer to data sheet N7720.





**Actuators**

**SQM33.4**

Rated torque 1.2 Nm (0.8 Nm holding torque when dead),  
running time 5 s, stepper motor, front mounting, D-type drive  
shaft.

See Data Sheet N7813.

**SQM33.5**

Rated torque 3 Nm (2.6 Nm holding torque when dead),  
running time 5 s, stepper motor, front mounting, D-type drive  
shaft.

See Data Sheet N7813.



**SQM33.7**

Rated torque 10 Nm (6 Nm holding torque when dead),  
running time 17 s, stepper motor, front mounting, D-type  
drive shaft.

See Data Sheet N7813.

---

**SQN1**

Rated torque 1 Nm (0.2 Nm holding torque when dead),  
running time 5 s, stepper motor, front mounting, D-type drive  
shaft.

See Data Sheet N7803.



Connector sets

**AGG3.131**

Article no.: **BPZ:AGG3.131**

Complete connector set RAST2.5 / RAST3.5 / RAST5 for gas / oil applications, single pack.

See Object List C7541 (74 319 0637 0).

Example: X5-02



**AGG3.132**

Article no.: **BPZ:AGG3.132**

Complete connector set RAST2.5 / RAST3.5 / RAST5 for gas- / oil applications, pack of 10.

See Object List C7541 (74 319 0637 0).

AGG3.131	AGG3.132	Connector type	Terminal	Description
1	10	RAST5	X3-02	Air pressure switch (LP)
1	10	RAST5	X3-03	Burner flange
1	10	RAST5	X3-04	Power supply (L, N, PE) for safety loop (SK)
1	10	RAST5	X3-05	<ul style="list-style-type: none"> <li>Alarm (AL)</li> <li>Fan motor (M)</li> </ul>
1	10	RAST5	X4-02	Ignition (Z)
1	10	RAST5	X5-01	<ul style="list-style-type: none"> <li>Gas pressure switch-min (Pmin)</li> <li>Oil pressure switch-min (Pmin)</li> </ul>
1	10	RAST5	X5-02	<ul style="list-style-type: none"> <li>Gas pressure switch-max (Pmax)</li> <li>Oil pressure switch-max (Pmax)</li> </ul>
1	10	RAST5	X5-03	External load controller (LR)
1	10	RAST5	X6-03	Safety valve (SV)
1	10	RAST5	X7-01	Fuel valve (V2)
1	10	RAST5	X7-02	Fuel valve (V3)
1	10	RAST5	X8-02	Fuel valve (V1)
1	10	RAST5	X8-04	Reset, operating mode display (B4)
1	10	RAST5	X9-04	<ul style="list-style-type: none"> <li>Gas pressure switch (GP)</li> <li>Pressure switch valve proving (P LT)</li> </ul>
1	10	RAST5	X10-05	Flame detector ION, QRB, QRC
1	10	RAST5	X10-06	Flame detector QRA2/QRA4
1	10	RAST5	X75	Fuel meter
1	10	RAST3.5	X64	<ul style="list-style-type: none"> <li>1 x 5-pin connector / reserve</li> <li>Load controller (LR) input (4–20 mA)</li> </ul>
1	10	RAST3.5	X74	1 x 5-pin connector / VSD
1	10	RAST2.5	X92	Modbus (COM)

**AGG3.162**Article no.: **BPZ:AGG3.162**

Connector set for AGM60.4A9 (US), RAST5, set of 10 AGM60.4A9.



AGG3.162	Connector type	Terminal	Description
10	RAST5	X5-01	Fuel 1: Pressure switch-min (Pmin)
10	RAST5	X5-02	Fuel 1: Pressure switch-max (Pmax) or POC
10	RAST5	X6-02	Fuel 1: Safety valve (SV) / Magnetic clutch
10	RAST5	X8-02	Fuel 1: Fuel valve (V1)
10	RAST5	X8-03	Fuel 1: Fuel valve (V2)
10	RAST5	X9-04	Fuel 0: Pressure switch valve proving (P LT)
10	RAST5	X22-02	Fuel 0: Pressure switch-max (Pmax) or POC
10	RAST5	X24-04	Fuel 0: Fuel valve 1 (V1) / fuel valve 2 (V2)
10	RAST5	X24-06	Fuel 0: Safety valve (SV)
10	RAST5	X31-01	<ul style="list-style-type: none"> <li>• Power supply</li> <li>• Fuel selector switch</li> </ul>
10	RAST5	X31-02	Fuel selector switch
10	RAST5	X32-01	Connection plug to basic unit LMV36
10	RAST5	X32-02	External load controller (LR)

**AGG9**  
Single connectors  
Packing unit 200 in total.

Example X5-03



Article no.	Type	Type of connector	Terminal	Description
BPZ:AGG9.203	AGG9.203	RAST5	X3-02	Air pressure switch (LP)
BPZ:AGG9.204	AGG9.204	RAST5	X3-03	Burner flange
BPZ:AGG9.206	AGG9.206	RAST5	X8-04	<ul style="list-style-type: none"> <li>Reset</li> <li>Operating display</li> </ul>
BPZ:AGG9.209	AGG9.209	RAST5	X10-06	Flame detector QRA2/QRA4/QRA10
BPZ:AGG9.217	AGG9.217	RAST5	X75	Fuel meter
BPZ:AGG9.303	AGG9.303	RAST5	X3-05	<ul style="list-style-type: none"> <li>Alarm (AL)</li> <li>Fan motor (M)</li> </ul>
BPZ:AGG9.304	AGG9.304	RAST5	X4-02	Ignition (Z)
BPZ:AGG9.306	AGG9.306	RAST5	X5-01	<ul style="list-style-type: none"> <li>Gas pressure switch-min (Pmin)</li> <li>Start release gas</li> </ul>
BPZ:AGG9.307	AGG9.307	RAST5	X5-02	<ul style="list-style-type: none"> <li>Gas pressure switch-max (Pmax)</li> <li>Oil pressure switch-max (Pmax)</li> <li>POC</li> <li>Start release oil</li> <li>Additional speed-dependent air pressure switch</li> </ul>
BPZ:AGG9.309	AGG9.309	RAST5	X6-03	<ul style="list-style-type: none"> <li>Safety valve (SV)</li> <li>Magnetic clutch</li> </ul>
BPZ:AGG9.310	AGG9.310	RAST5	X7-01	Fuel valve (V2)
BPZ:AGG9.311	AGG9.311	RAST5	X7-02	<ul style="list-style-type: none"> <li>Pilot valve (PV)</li> <li>Fuel valve (V3)</li> </ul>
BPZ:AGG9.313	AGG9.313	RAST5	X9-04	<ul style="list-style-type: none"> <li>Pressure switch valve proving (P LT)</li> <li>Oil pressure switch-min (Pmin)</li> </ul>
BPZ:AGG9.403	AGG9.403	RAST5	X5-03	<ul style="list-style-type: none"> <li>Fuel selection</li> <li>External load controller (LR)</li> </ul>
BPZ:AGG9.406	AGG9.406	RAST5	X8-02	Fuel valve (V1)
BPZ:AGG9.501	AGG9.501	RAST5	X3-04	Power supply (L, N, PE) for safety loop (SK)
BPZ:AGG9.504	AGG9.504	RAST5	X10-05	Flame detector ION, QRB, QRC
BPZ:AGG9.853	AGG9.853	RAST3.5	X64	<ul style="list-style-type: none"> <li>External load controller (LR)</li> <li>PWM fan</li> </ul>
BPZ:AGG9.853	AGG9.853	RAST3.5	X74	<ul style="list-style-type: none"> <li>Load output (0/0–10 V)</li> <li>Variable speed drive (VSD)</li> </ul>

## Ordering (cont'd)

---

### Accessories

#### **AGG5.310**

Article no.: **BPZ:AGG5.310**

Accessories set speed control, for burner management systems, composed of sensor disk Ø 50, sensor and mounting set.

See Mounting instructions M7550.1 (74 319 9322 0).



### Cables

#### **AGV50.100**

Article no.: **BPZ:AGV50.100**

Signal cable for AZL2, with RJ11 connector, length 1 m, pack of 10.

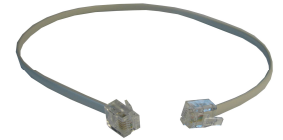

#### **AGV50.300**

Article no.: **BPZ:AGV50.300**

Signal cable for AZL2, with RJ11 connector, length 3 m, pack of 10.

#### **AGV61.100**

Article no.: **BPZ:AGV61.100**

Connecting cable between LMV36 and AGM60 (US), cable length 1 m.

Refer to Basic Documentation P7544.



## Ordering (cont'd)

---

### Proportional controlling element with mounting plate

#### **VKP**

Proportional controlling element for mounting between threaded flanges in gas trains.  
Refer to Data Sheet N7646



---

#### **ASK33.1**

Article no.: **BPZ:ASK33.1**

Larger mounting plate required to replace existing mounting plate. Required for mounting the actuators SQM4 or SQM33.

Refer to Data Sheet N7646.



---

#### **ASK33.2**

Article no.: **BPZ:ASK33.2**

Additional mounting plate is required for mounting the actuator SQN13.

Refer to Data Sheet N7646.



---

### Gas damper for mounting kit

#### **VKF41.xxxC**

Butterfly valves designed in intermediate flange design, for integration into gas trains.

Refer to Data Sheet N7632.

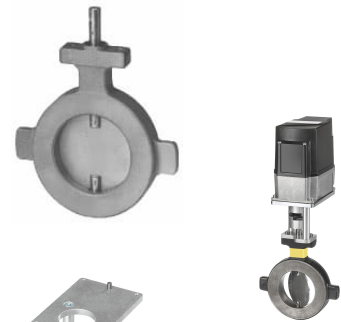

#### **ASK33.4**

Article no.: **BPZ:ASK33.4**

Mounting kit for mounting the actuators SQM33.5 on the butterfly valve VKF41.xxxC.

Refer to Data Sheet N7632.

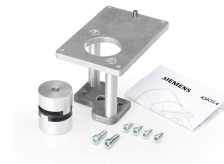

---

### Transformer

#### **A5Q20002669**

Article no.: **BPZ:A5Q20002669**

Transformer to increase ionization voltage for AC 120 V devices.

See User Documentation A7541.2.



Connection and internal diagram LMV36

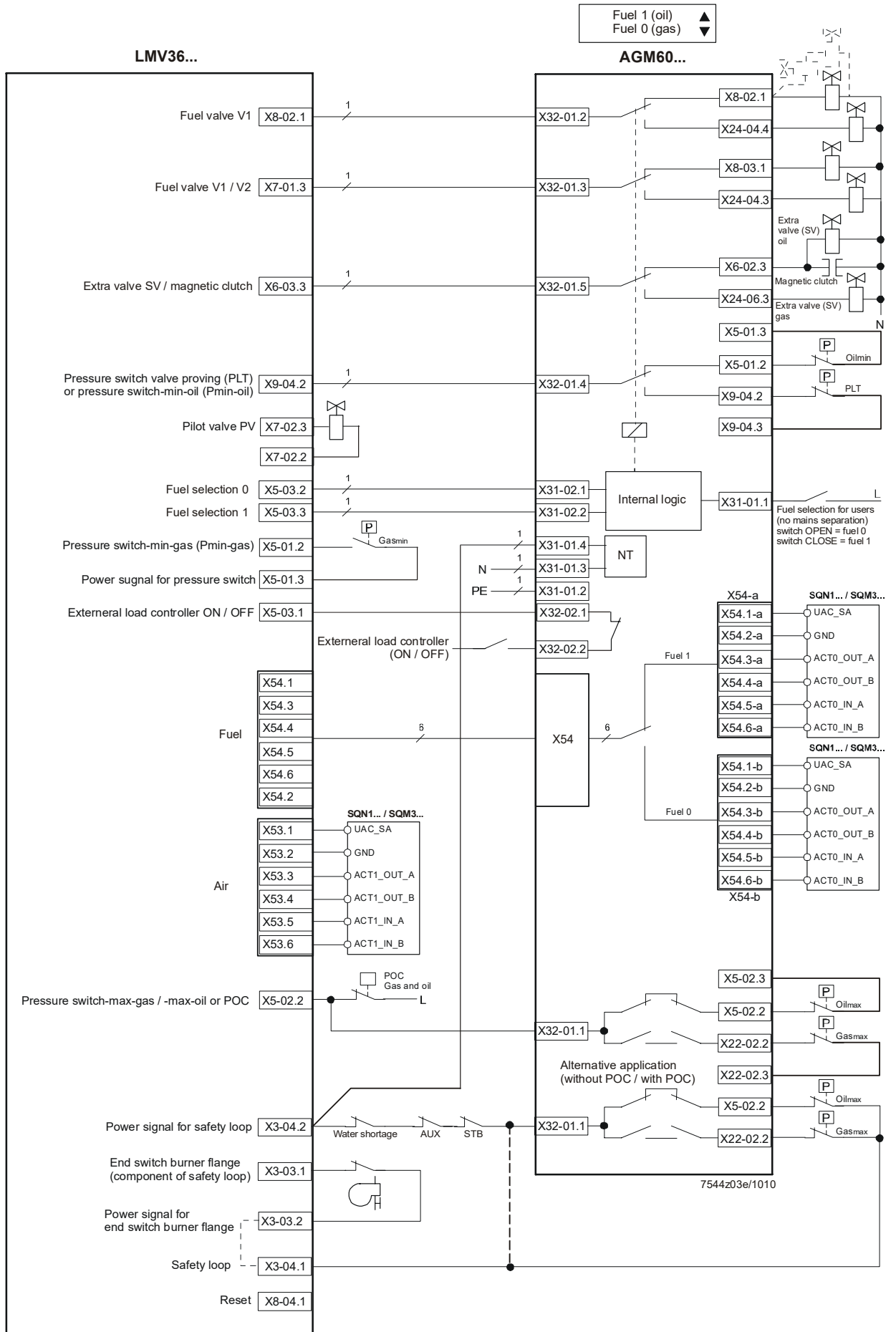

## Connection and internal diagram LMV36 (cont'd)

Shielding:

For shielding the cables on the VSD, refer to:

- Siemens *SED2* VSD Commissioning Manual (G5192), chapter 4 and chapter 7, or
- Danfoss Operation Manual *VLT 6000* (MG60A703), chapter *Installation*

### Switching between 2 ratio control curves

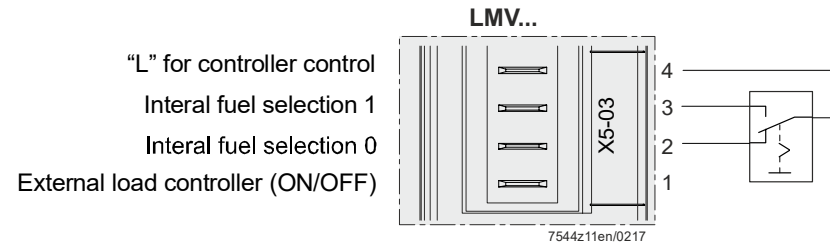



## Technical Data

### Basic unit LMV36

#### General

Mains voltage	AC 120 V -15% / +10%
Mains frequency	50 / 60 Hz ±6%
Power consumption	<30 W (typically)
Safety class	I with parts according to II and III to EN 60730-1:2016
Degree of protection	IP00 to EN 60529:1991 + A1:2000 + A2:2013

#### Note

The burner or boiler manufacturer must ensure degree of protection IP40 for LMV36 as per EN 60529:1991 + A1:2000 + A2:2013 through adequate installation.

Mode of operation	Type 2B in accordance with EN 60730-1:2016
Rated surge voltage	In accordance with EN 60730-1:2016, section 20 (OC III)
Voltage and current for the purposes of the EMC emitted interference tests	The emitted interference measurement test takes place with mains voltage and maximum power consumption

#### Terminal loading «Inputs»

Permissible primary fuse (Si) (external)	Max. 16 AT
--	------------



#### Caution!

#### Risk of damage to the switching contacts!

If the external primary fuse (Si) is blown due to overload or short-circuit at the terminals, the LMV36 must be replaced.

Unit fuse F1 (internal)	6.3 AT (IEC 60127-2:2014)
Mains supply: Input current depending on the operating state of the unit	
Undervoltage	
• Safety shutdown from operating position at mains voltage	Approx. AC 93 V
• Restart on rise in mains voltage	Approx. AC 96 V
Status inputs: Status inputs (with the exception of the safety loop) of the contact feedback network (KRN) are used for system supervision and require mains-related input voltage	
• Input safety loop	Refer to <i>Terminal loading outputs</i>
Input currents and input voltages	
- UeMax	UN +10%
- UeMin	UN -15%
- IeMax	1,5 mA peak
- IeMin	0,7 mA peak
Contact material recommendation for external signal sources (air pressure switch, pressure switch-min, pressure switch-max, etc.)	Gold-plated silver contacts
Transition / settling behavior / bounce	
- Perm. bounce time of contacts when switching on / off	Max. 50 ms (after the bounce time, contact must stay closed or open)
UN	AC 120 V
Voltage detection	
- On	AC 90...132 V
- Off	<AC 40 V

## Technical Data (cont'd)

Terminal loading  
«Outputs»

### Total contact loading:

- Rated voltage AC 120 V, 50 / 60 Hz
- Unit input current (safety loop) from: Max. 5 A
  - Fan motor contactor
  - Ignition transformer
  - Fuel valves
  - Oil pump / magnetic clutch  
(optional via AGM60)

### Individual contact loading:

#### Fan motor contactor

- Rated voltage AC 120 V, 50 / 60 Hz
- Rated current 1.6 A pilot duty output declaration to UL372
- Power factor  $\text{Cos}\varphi > 0.4$

#### Alarm output

- Rated voltage AC 120 V, 50 / 60 Hz
- Rated current 1 A
- Power factor  $\text{Cos}\varphi > 0.4$

#### Ignition transformer

- Rated voltage AC 120 V, 50 / 60 Hz
- Rated current 1.6 A pilot duty output declaration to UL372  
or  
250 VA ignition output declaration to UL372
- Power factor  $\text{Cos}\varphi > 0.2$

#### Fuel valves

- Rated voltage AC 120 V, 50 / 60 Hz
- Rated current 1.6 A pilot duty output declaration to UL372
- Power factor  $\text{Cos}\varphi > 0.4$

#### Operation display

- Rated voltage AC 120 V, 50 / 60 Hz
- Rated current 0,5 A
- Power factor  $\text{Cos}\varphi > 0.4$

#### Safety valve (magnetic clutch / oil pump)

- Rated voltage AC 120 V, 50 / 60 Hz
- Rated current 1.6 A pilot duty output declaration to UL372
- Power factor  $\text{Cos}\varphi > 0.4$

#### Connections for pressure switch

- Rated voltage AC 120 V, 50 / 60 Hz
- Rated current 1.5 mA
- Power factor ---

#### Power supply for pressure switch-max / POC (X5-02 pin 3 or X22-02 pin 3)

- I<sub>aMax</sub> <10 mA

#### Fuel feedback to LMV36 (X31-02 pin 1 or X31-02 pin 2)

- I<sub>aMax</sub> <10 mA

Analog output / load  
output X74 pin 3

- Accuracy of output voltage  $\pm 1 \%$

## Technical Data (cont'd)

Cable lengths	Mains line AC 120 V	Max. 100 m (100 pF/m)
	Display, BCI	For installation under the burner hood or in the control panel Max. 3 m (100 pF/m)
	Load controller X5-03	Max. 20 m (100 pF/m)
	Load controller analog X64 (24 mA)	Max. 20 m (100 pF/m)
	Safety loop / burner flange (total)	Max. 20 m (100 pF/m)
	External lockout reset button	Max. 20 m (100 pF/m)
	Safety valve	Max. 20 m (100 pF/m)
	Load output <sup>1)</sup>	Max. 10 m (100 pF/m)
	VSD control <sup>2)</sup>	Max. 3 m (100 pF/m)
	Speed input	Max. 3 m (100 pF/m)
	Fuel valve (V1 / V2 / V3)	Max. 3 m (100 pF/m)
	Pilot valve	Max. 3 m (100 pF/m)
	Ignition transformer	Max. 3 m (100 pF/m)
	Other lines	Max. 3 m (100 pF/m)

<sup>1)</sup> Do not run the cable together with other cables. If not observed, hum voltage might cause electromagnetic interference

<sup>2)</sup> Shorter cable length due to closed control loop

### Specification as per EN 60730-1:2016

Type of shutdown or interruption of each circuit

Shutdown with microswitch 1-pole

Mode of operation Type 2 B

Cross-sectional areas The cross-sectional areas of the mains power lines (L, N, and PE) and, if required, the safety loop (safety limit thermostat, water shortage, etc.) must be sized for rated currents according to the selected external primary fuse. The cross-sectional areas of the other cables must be sized in accordance with the internal unit fuse (max. 6.3 AT).

Min. cross-sectional area	0.75 mm <sup>2</sup> (single- or multi-core as per VDE 0100)
---------------------------	--

Cable insulation must meet the relevant temperature requirements and environmental conditions.

Fuses (F1) used inside the LMV36	6.3 AT (IEC 60127 2:2014)
----------------------------------	---------------------------

### Connections of actuators

The fixed connected actuator cables must not be extended.

#### AGV50 signal cable

AZL2 → BCI

<b>Signal cable</b>	Color white Unshielded Conductor 4 x 0.141 mm <sup>2</sup> With RJ11-plug
Cable length	
- AGV50.100	1 m
- AGV50.300	3 m
Location	Under the burner hood (extra measures required for SKII EN 60730-1:2016)

## Technical Data (cont'd)

### Environmental conditions

<b>Storage</b>	EN 60721-3-1:1997
Climatic conditions	Class 1K3
Mechanical conditions	Class 1M2
Temperature range	-20...+60 °C
Humidity	<95 % r.h.
<b>Transport</b>	EN 60721-3-2:1997
Climatic conditions	Class 2K2
Mechanical conditions	Class 2M2
Temperature range	-30...+60 °C
Humidity	<95 % r.h.
<b>Operation</b>	EN 60721-3-3:1995 + A2:1997
Climatic conditions	Class 3K3
Mechanical conditions	Class 3M3
Temperature range	-20...+60 °C
Humidity	<95 % r.h.
Installation altitude	Max. 2,000 m above sea level



**Caution!**  
Condensation, formation of ice and ingress of water are not permitted!

## Technical Data (cont'd)

### Flame supervision with ionization probe

No-load voltage at ION terminal (X10-05 pin 2)

Approx.  $U_{Mains}$



#### Caution!

**The ionization probe must be protected against electric shock hazard (electric shock hazard)!**

Short-circuit current

Max. AC 1 mA

Required detector current

Min. DC 2.3  $\mu$ A,  
flame display approx. 30 %

When the more sensitive flame supervision is activated, the required detector current is halved (refer to chapter *Flame detection sensitivity* in the Basic Documentation P7544).

Possible detector current

Max. DC 12...30  $\mu$ A, flame display approx. 100 %

Max. perm. length of detector cable (laid separately)

3 m (wire-ground 100 pF/m)



#### Warning!

**Simultaneous operation of QRA and ionization probe is not permitted!**



#### Note

The higher the detector cable's capacitance (cable length), the more voltage at the ionization probe, and thus the detector current, drops. Long cable lengths plus very highly resistive flames might necessitate low-capacitance detector cables (e.g. ignition cable). In spite of technical measures taken in the circuitry aimed at compensating potential adverse effects of the ignition spark on the ionization current, it must be made certain that the minimum detector current required will already be reached during the ignition phase. If this is not the case, the connections on the primary side of the ignition transformer must be changed and / or the electrodes relocated.

Threshold values when flame is supervised by an ionization probe:

- Start prevention (extraneous light)

Flame intensity (parameter 954)  $\geq 18$  %

- Operation

Flame intensity (parameter 954)  $> 24$  %

Ionization input

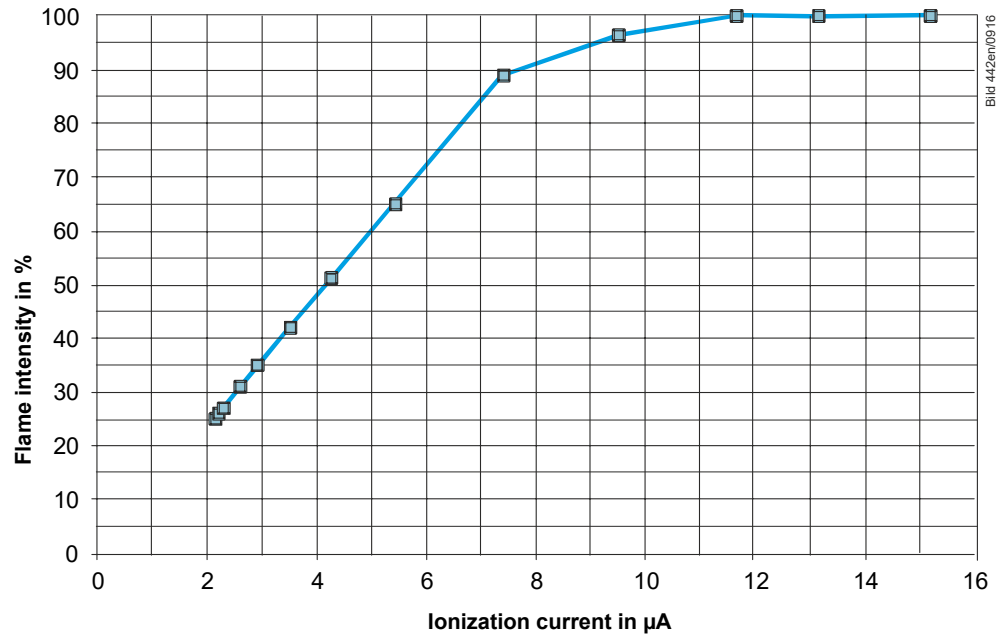

Measuring circuit for detector current measurement

Ionization probe

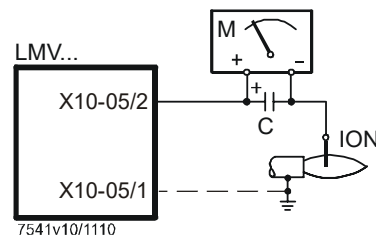

Legend

- C Electrolytic capacitor 100...470  $\mu\text{F}$ ; DC 10...25 V
- ION Ionization probe
- M Microammeter  $R_i$  max. 5000  $\Omega$

## Technical Data (cont'd)

### Flame supervision with QRA2 / QRA4 / QRA10



#### Warning!

If UV flame detectors QRA2 / QRA4 / QRA10 are used for flame supervision with the LMV36, it must be ensured that the LMV36 is permanently connected to power (conforming to DIN EN 298), thus enabling the LMV36 to detect flame detector failures during startup and shutdown. Generally, the system works with QRA flame detectors in intermittent operation. *Technical Data* refer to Data Sheet N7712 covering UV flame detectors QRA2 / QRA10! *Technical Data* refer to Data Sheet N7711 covering UV flame detectors QRA4!

Operating voltage	Max. 350 V peak
Required detector current in operation	Min. 30 $\mu$ A
Possible detector current in operation	Max. 600 $\mu$ A
Permissible length of flame detector cable, normal cable (laid separately)	Max. 6 m
Threshold values when flame is supervised by QRA: - Start prevention (extraneous light) Flame intensity (parameter 954) $\geq 18$ % - Operation Flame intensity (parameter 954) $> 24$ %	

When the more sensitive flame supervision is activated, the required detector current is halved (refer to chapter *Flame detection sensitivity* in the Basic Documentation P7544).

### Measuring circuit for detector current measurement

#### UV flame detector QRA

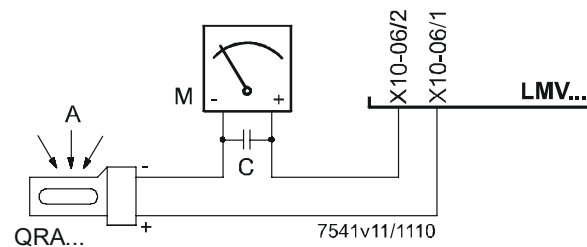

#### Legend

- A Incidence of light
- C Electrolytic capacitor 100...470  $\mu$ F; DC 10...25 V
- M Microammeter  $R_i$  max. 5000  $\Omega$



#### Warning!

- Input QRA... is not short-circuit-proof!
- Short-circuits of X10-06 pin 2 against earth can destroy the QRA input
- Simultaneous operation of QRA and ionization probe is not permitted!

## Technical Data (cont'd)

### Flame supervision with QRB1/QRB3

No-load voltage at QRB1/QRB3 terminal (X10-05 pin 3)	Approx. DC 5 V
Max. perm. length of QRB1/QRB3 detector cable (laid separately)	3 m (wire – wire 100 pF/m)



#### Note

A detector resistance of  $R_F < 500 \Omega$  is identified as a short-circuit and leads to safety shutdown in operation as if the flame had been lost.

For this reason, before considering the use of a highly sensitive photoresistive detector (QRB1B or QRB3S), it should be checked whether this type of flame detector is indeed required! Increased line capacitance between QRB1/QRB3 connection and mains live wire  $L$  has an adverse effect on the sensitivity and increases the risk of damaged flame detectors due to overvoltage. Always run detector cables separately!

#### Threshold values when flame is supervised by QRB1/QRB3

Start prevention (extraneous light) with <b>RQRB</b>	Approx. 400 k $\Omega$ Flame intensity $\geq 10\%$
Operation with <b>RQRB</b>	Approx. 230 k $\Omega$ Flame intensity $> 16\%$
Short-circuit detection with <b>RQRB</b>	$< 0,5 \text{ k}\Omega$

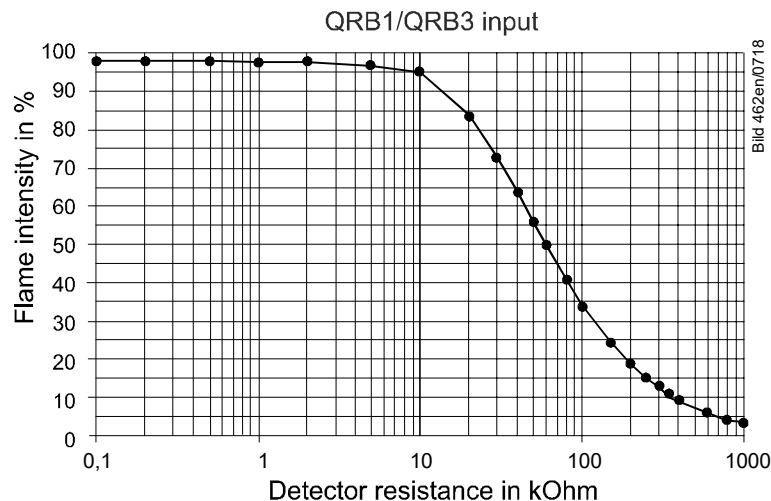

A flame detector resistance of  $R_F < 500 \Omega$  is identified as a short-circuit and leads to safety shutdown in operation, like in the case of loss of flame.



#### Note!

In the case of the QRB1/QRB3, the maximum intensity display is limited to approximately 40% due to the system.



## Technical Data (cont'd)

### Flame supervision with QRB4

Open-circuit voltage at terminal QRB4 (X10-05 pin 3)	Approx. 5 V DC
Permissible length of QRB4 detector cable (laid separately)	3 m (wire to wire 100 pF/m)
Threshold values when flame is supervised by QRB4	
Start prevention (extraneous light)	Flame intensity (parameter 954) $\geq 10\%$
Operation	Flame intensity (parameter 954) $> 16\%$



#### Note!

In the case of the QRB4, the maximum intensity display is limited to approximately 40% due to the system (parameter 954).



#### Note!

##### Connection of QRB4 cables!

Blue cable of QRB4 to terminal X10-05 pin 4.  
Black cable of QRB4 to terminal X10-05 pin 3.  
Otherwise, the QRB4 will not work.

## Technical Data (cont'd)

### Dual fuel switch unit AGM60

Mains voltage	AC 120 V -15% / +10%
Mains frequency	50/60 Hz ±6%
Power consumption	<5 W (typically) (without actuator supply)
Safety class	I with parts according to II and III to EN 60730-1:2016
Galvanic separation between mains voltage terminals and actuator signal lines and actuator supply lines	No
Degree of protection	IP00 according to EN 60529:1991 + A1:2000 + A2:2013



#### Note:

The burner or boiler manufacturer (OEM) must ensure degree of protection IP40 to EN 60529:1991 + A1:2000 + A2:2013 for burner controls by adequate installation of the AGM60...

The AGM60 together with the LMV36 is suited for installation under the burner hood or inside a control cabinet or control panel

Detection time fuel changeover	<400 ms
Switching frequency fuel changeover	Min. 3 s
Switching cycles fuel changeover	Max. 5'000
Permissible primary fuse (Si) (external)	Max. 6.3 AT Power must always be supplied via the LMV36 (refer to chapter <i>Inputs / Outputs</i> )



#### Caution!

**Risk of damage to the switching contacts!**

**If the external primary fuse (Si) is blown due to overload or short-circuit at the terminals, the AGM60 must be replaced.**

Mains supply:	
Input current depending on the operating state of the LMV36	
Mains voltage is monitored by the burner control	
Dimensions (W x H x D)	180.7 x 120.7 x 51.7 mm
Mounting	Top hat rail to DIN EN 60715, 35 mm or screwed

### Terminal output *Inputs*

Status input: Fuel selection, pressure switch	
• Input currents and input voltages	
- UeMax	UN +10%
- UeMin	UN -15%
- IeMax	1.5 mA peak
- IeMin	0.7 mA peak
• Contact material recommendation for external switching contact, transducer (pressure switch-max, POC)	Gold-plated silver contacts
• Transition / settling behavior / bounce	
- Perm. bounce time of contacts when switching on/off	Max. 50 ms (after the bounce time, the contact must stay closed or open)
• UN	AC 120 V
• Voltage detection	
- On	AC 90...132 V
- Off	<AC 40 V

## Technical Data (cont'd)

### Terminal output *Outputs*

#### Total contact output:

- Rated voltage AC 120 V, 50/60 Hz

Refer also *Total contact output* in chapter *Terminal output Outputs*

#### Individual contact loads:

##### Fuel valve

- Rated voltage AC 120 V, 50/60 Hz
- Rated current 1.6 pilot duty output declaration to UL732
- Power factor  $\text{Cos}\phi > 0.4$

##### Safety valve (magnetic clutch / oil pump)

- Rated voltage AC 120 V, 50/60 Hz
- Rated current 1.6 A pilot duty output declaration to UL732
- Power factor  $\text{Cos}\phi > 0.4$

##### Connections for pressure switch

- Rated voltage AC 120 V, 50/60 Hz
- Rated current 1.5 mA
- Power factor ---

##### Power supply for pressure switch-max / POC (X5-02 pin 3 or X22-02 pin 3)

- laMax <10 mA

##### Fuel feedback to LMV36... (X31-02 pin 1 or X31-02 pin 2)

- laMax <10 mA

### Cable lengths

Mains line LMV36 → AGM60 Max. 3 m (100 pF/m)

Fuel valves Max. 3 m (100 pF/m)

Other lines Max. 3 m (100 pF/m)

Fuel selector Max. 20 m (100 pF/m)

Load controller Max. 20 m (100 pF/m)

#### Specification as per EN 60730-1:2016

Type of shutdown or interruption of each circuit

Shutdown with microswitch Single-pole

Mode of operation Type 2 B

### Cross-sectional areas

The cross-sectional areas of the power supply lines (L, N and PE) must be capable of carrying the rated currents according to the built-in unit fuse of the respective LMV36 (max. 6.3 AT).

Cross-sectional area Min. 0.75 mm<sup>2</sup> (single- or multi-core to VDE 0100)

Cable insulations must satisfy the relevant temperature requirements and environmental conditions.

### Electrical connections of actuators

The fixed connected actuator cables must not be extended.

## Technical Data (cont'd)

Environmental conditions	<b>Storage</b>	EN 60721-3-1:1997
	Climatic conditions	Class 1K3
	Mechanical conditions	Class 1M2
	Temperature range	-20...+60 °C
	Humidity	<95% r.h.
	<b>Transport</b>	EN 60721-3-2:1997
	Climatic conditions	Class 2K2
	Mechanical conditions	Class 2M2
	Temperature range	-30...+60 °C
	Humidity	<95% r.h.
	<b>Operation</b>	EN 60721-3-3:1995 + A2:1997
	Climatic conditions	Class 3K3
	Mechanical conditions	Class 3M3
Temperature range	-20...+60 °C	
Humidity	<95% r.h.	
Installation altitude	Max. 2,000 m above sea level	



**Caution!**  
Condensation, formation of ice and ingress of water are not permitted!

# Dimensions

Dimensions in mm

LMV36



Bild 269/0309

Dimensions in mm

AGM60

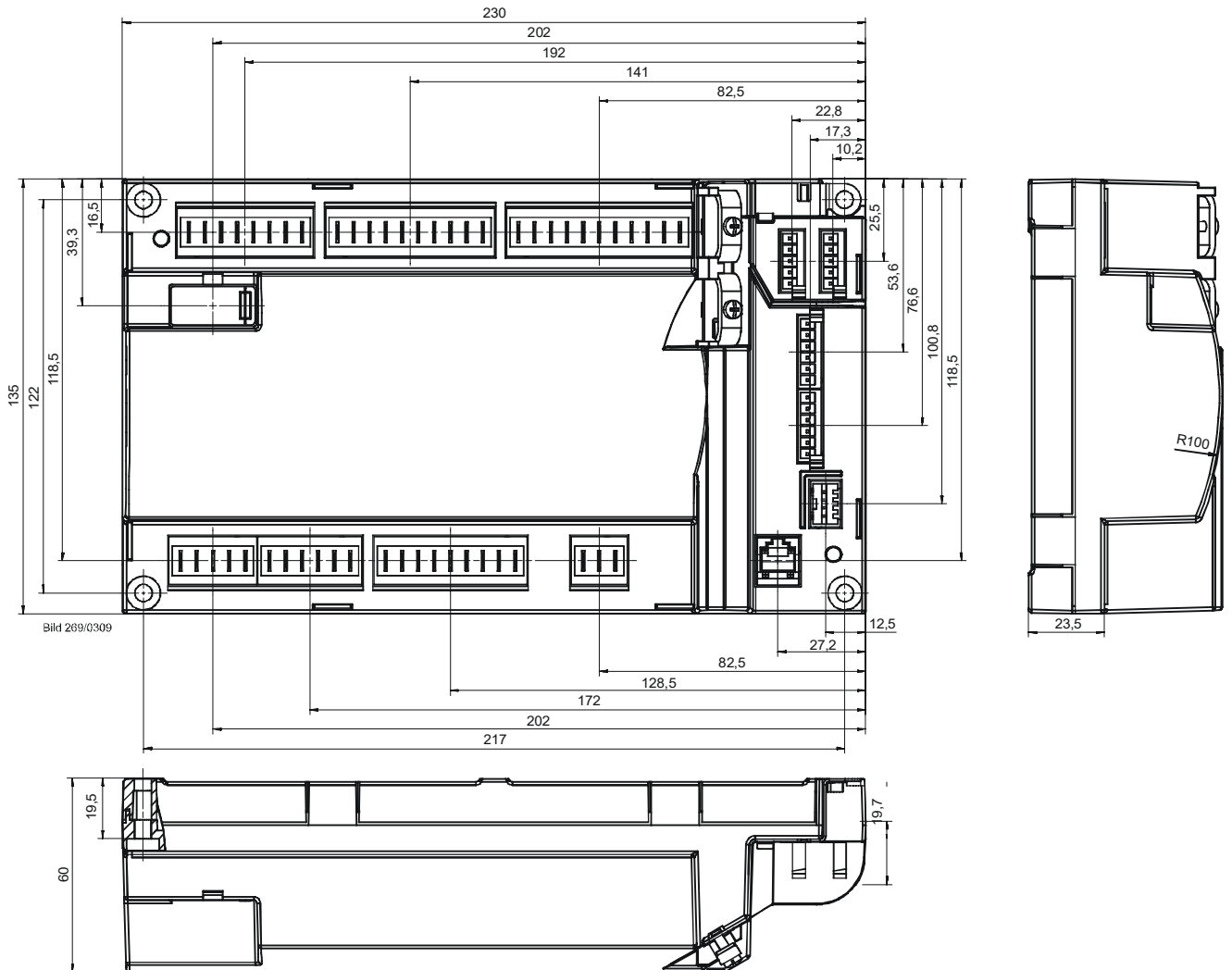